

DS90C363/DS90CF364 +3.3V Programmable LVDS Transmitter 18-Bit Flat Panel Display (FPD) Link—65 MHz, +3.3V LVDS Receiver 18-Bit Flat Panel Display (FPD) Link—65 MHz

General Description

The DS90C363 transmitter converts 21 bits of CMOS/TTL data into three LVDS (Low Voltage Differential Signaling) data streams. A phase-locked transmit clock is transmitted in parallel with the data streams over a fourth LVDS link. Every cycle of the transmit clock 21 bits of input data are sampled and transmitted. The DS90CF364 receiver converts the LVDS data streams back into 21 bits of CMOS/TTL data. At a transmit clock frequency of 65 MHz, 18 bits of RGB data and 3 bits of LCD timing and control data (FPLINE, FPFAME, DRDY) are transmitted at a rate of 455 Mbps per LVDS data channel. Using a 65 MHz clock, the data throughput is 170 Mbytes/sec. The Transmitter is offered with programmable edge data strobes for convenient interface with a variety of graphics controllers. The Transmitter can be programmed for Rising edge strobe or Falling edge strobe through a dedicated pin. A Rising edge Transmitter will interoperate with a Falling edge Receiver (DS90CF364) without any translation logic.

This chipset is an ideal means to solve EMI and cable size problems associated with wide, high speed TTL interfaces.

Features

- 20 to 65 MHz shift clock support
- Programmable Transmitter (DS90C363) strobe select (Rising or Falling edge strobe)
- Single 3.3V supply
- Chipset (Tx + Rx) power consumption < 250 mW (typ)
- Power-down mode (< 0.5 mW total)
- Single pixel per clock XGA (1024x768) ready
- Supports VGA, SVGA, XGA and higher addressability.
- Up to 170 Megabyte/sec bandwidth
- Up to 1.3 Gbps throughput
- Narrow bus reduces cable size and cost
- 290 mV swing LVDS devices for low EMI
- PLL requires no external components
- Low profile 48-lead TSSOP package
- Falling edge data strobe Receiver
- Compatible with TIA/EIA-644 LVDS standard
- ESD rating > 7 kV
- Operating Temperature: -40°C to +85°C

Block Diagrams

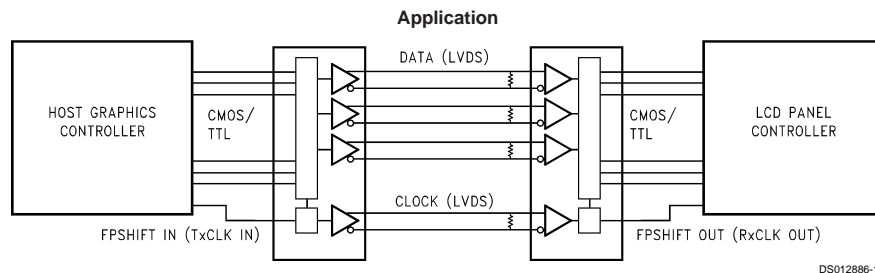

TRI-STATE® is a registered trademark of National Semiconductor Corporation.

Block Diagrams (Continued)

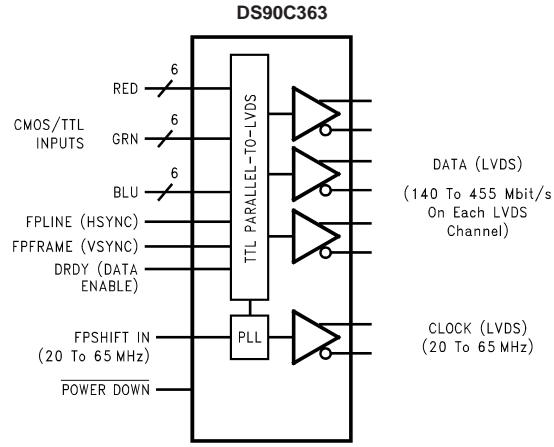

DS012886-1

Order Number DS90C363MTD
See NS Package Number MTD48

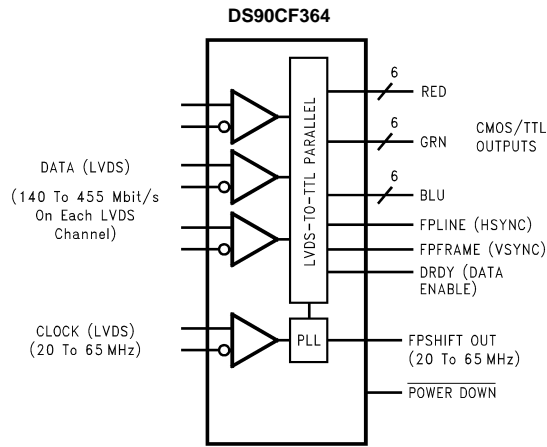

DS012886-24

Order Number DS90CF364MTD
See NS Package Number MTD48

Absolute Maximum Ratings (Note 1)

If Military/Aerospace specified devices are required, please contact the National Semiconductor Sales Office/Distributors for availability and specifications.

Supply Voltage (V_{CC})	-0.3V to +4V
CMOS/TTL Input Voltage	-0.3V to ($V_{CC} + 0.3V$)
CMOS/TTL Output Voltage	-0.3V to ($V_{CC} + 0.3V$)
LVDS Receiver Input Voltage	-0.3V to ($V_{CC} + 0.3V$)
LVDS Driver Output Voltage	-0.3V to ($V_{CC} + 0.3V$)
LVDS Output Short Circuit Duration	Continuous
Junction Temperature	+150°C
Storage Temperature	-65°C to +150°C
Lead Temperature (Soldering, 4 sec)	+260°C
Maximum Package Power Dissipation Capacity 25°C MTD48 (TSSOP) Package:	

DS90C363	1.98 W
DS90CF364	1.89 W
Package Derating:	
DS90C363	16 mW/°C above +25°C
DS90CF364	15 mW/°C above +25°C
ESD Rating (HBM, 1.5 kΩ, 100 pF)	> 7 kV

Recommended Operating Conditions

	Min	Nom	Max	Units
Supply Voltage (V_{CC})	3.0	3.3	3.6	V
Operating Free Air Temperature (T_A)	-40	+25	+85	°C
Receiver Input Range	0		2.4	V
Supply Noise Voltage (V_{CC})			100	mV _{PP}

Electrical Characteristics

Over recommended operating supply and temperature ranges unless otherwise specified.

Symbol	Parameter	Conditions	Min	Typ	Max	Units	
CMOS/TTL DC SPECIFICATIONS							
V_{IH}	High Level Input Voltage		2.0		V_{CC}	V	
V_{IL}	Low Level Input Voltage		GND		0.8	V	
V_{OH}	High Level Output Voltage	$I_{OH} = -0.4$ mA	2.7	3.3		V	
V_{OL}	Low Level Output Voltage	$I_{OL} = 2$ mA		0.06	0.3	V	
V_{CL}	Input Clamp Voltage	$I_{CL} = -18$ mA		-0.79	-1.5	V	
I_{IN}	Input Current	$V_{IN} = V_{CC}$, GND, 2.5V or 0.4V		±5.1	±10	μA	
I_{OS}	Output Short Circuit Current	$V_{OUT} = 0V$		-60	-120	mA	
LVDS DC SPECIFICATIONS							
V_{OD}	Differential Output Voltage	$R_L = 100\Omega$	250	345	450	mV	
ΔV_{OD}	Change in V_{OD} between complimentary output states				35	mV	
V_{OS}	Offset Voltage (Note 4)		1.125	1.25	1.375	V	
ΔV_{OS}	Change in V_{OS} between complimentary output states				35	mV	
I_{OS}	Output Short Circuit Current	$V_{OUT} = 0V$, $R_L = 100\Omega$		-3.5	-5	mA	
I_{OZ}	Output TRI-STATE® Current	$\overline{PWR\ DWN} = 0V$, $V_{OUT} = 0V$ or V_{CC}		±1	±10	μA	
V_{TH}	Differential Input High Threshold	$V_{CM} = +1.2V$			+100	mV	
V_{TL}	Differential Input Low Threshold		-100			mV	
I_{IN}	Input Current	$V_{IN} = +2.4V$, $V_{CC} = 3.6V$ $V_{IN} = 0V$, $V_{CC} = 3.6V$			±10	μA	
TRANSMITTER SUPPLY CURRENT							
ICCTW	Transmitter Supply Current, Worst Case	$R_L = 100\Omega$, $C_L = 5$ pF, Worst Case Pattern (Figures 1, 3), $T_A = -40^\circ C$ to +85°C	$f = 32.5$ MHz		31	45	mA
			$f = 37.5$ MHz		32	50	mA
			$f = 65$ MHz		42	55	mA
ICCTG	Transmitter Supply Current, 16 Grayscale	$R_L = 100\Omega$, $C_L = 5$ pF, 16 Grayscale Pattern (Figures 2, 3), $T_A = -40^\circ C$ to +85°C	$f = 32.5$ MHz		23	35	mA
			$f = 37.5$ MHz		28	40	mA
			$f = 65$ MHz		31	45	mA

Electrical Characteristics (Continued)

Over recommended operating supply and temperature ranges unless otherwise specified.

Symbol	Parameter	Conditions	Min	Typ	Max	Units	
TRANSMITTER SUPPLY CURRENT							
ICCTZ	Transmitter Supply Current Power Down	PWR DWN = Low Driver Outputs in TRI-STATE® under Power Down Mode		10	55	μA	
RECEIVER SUPPLY CURRENT							
ICCRW	Receiver Supply Current, Worst Case	$C_L = 8$ pF, Worst Case Pattern (Figures 1, 4), $T_A = -40^\circ\text{C}$ to $+85^\circ\text{C}$	$f = 32.5$ MHz		49	65	mA
			$f = 37.5$ MHz		53	70	mA
			$f = 65$ MHz		78	105	mA
ICCRG	Receiver Supply Current, 16 Grayscale	$C_L = 8$ pF, 16 Grayscale Pattern (Figures 2, 4), $T_A =$ -40°C to $+85^\circ\text{C}$	$f = 32.5$ MHz		28	45	mA
			$f = 37.5$ MHz		30	47	mA
			$f = 65$ MHz		43	60	mA
ICCRZ	Receiver Supply Current Power Down	PWR DWN = Low Receiver Outputs Stay Low during Power Down Mode		10	55	μA	

Note 1: "Absolute Maximum Ratings" are those values beyond which the safety of the device cannot be guaranteed. They are not meant to imply that the device should be operated at these limits. The tables of "Electrical Characteristics" specify conditions for device operation.

Note 2: Typical values are given for $V_{CC} = 3.3\text{V}$ and $T_A = +25^\circ\text{C}$.

Note 3: Current into device pins is defined as positive. Current out of device pins is defined as negative. Voltages are referenced to ground unless otherwise specified (except V_{OD} and ΔV_{OD}).

Note 4: V_{OS} previously referred as V_{CM} .

Transmitter Switching Characteristics

Over recommended operating supply and -40°C to $+85^{\circ}\text{C}$ ranges unless otherwise specified

Symbol	Parameter	Min	Typ	Max	Units	
LLHT	LVDS Low-to-High Transition Time (Figure 3)		0.75	1.5	ns	
LHLT	LVDS High-to-Low Transition Time (Figure 3)		0.75	1.5	ns	
TCIT	TxCLK IN Transition Time (Figure 5)			5	ns	
TCCS	TxOUT Channel-to-Channel Skew (Figure 6)		250		ps	
TPPos0	Transmitter Output Pulse Position for Bit 0 (Figure 17)	f = 65 MHz	-0.4	0	0.3	ns
TPPos1	Transmitter Output Pulse Position for Bit 1		1.8	2.2	2.5	ns
TPPos2	Transmitter Output Pulse Position for Bit 2		4.0	4.4	4.7	ns
TPPos3	Transmitter Output Pulse Position for Bit 3		6.2	6.6	6.9	ns
TPPos4	Transmitter Output Pulse Position for Bit 4		8.4	8.8	9.1	ns
TPPos5	Transmitter Output Pulse Position for Bit 5		10.6	11.0	11.3	ns
TPPos6	Transmitter Output Pulse Position for Bit 6		12.8	13.2	13.5	ns
TCIP	TxCLK IN Period (Figure 7)	15	T	50	ns	
TCIH	TxCLK IN High Time (Figure 7)	0.35T	0.5T	0.65T	ns	
TCIL	TxCLK IN Low Time (Figure 7)	0.35T	0.5T	0.65T	ns	
TSTC	TxIN Setup to TxCLK IN (Figure 7)	f = 65 MHz	2.5			ns
THTC	TxIN Hold to TxCLK IN (Figure 7)		0			ns
TCCD	TxCLK IN to TxCLK OUT Delay 25°C , $V_{\text{CC}} = 3.3\text{V}$ (Figure 9)	3.0	3.7	5.5	ns	
TPLLS	Transmitter Phase Lock Loop Set (Figure 11)			10	ms	
TPDD	Transmitter Power Down Delay (Figure 15)			100	ns	

Receiver Switching Characteristics

Over recommended operating supply and -40°C to $+85^{\circ}\text{C}$ ranges unless otherwise specified

Symbol	Parameter	Min	Typ	Max	Units	
CLHT	CMOS/TTL Low-to-High Transition Time (Figure 4)		2.2	5.0	ns	
CHLT	CMOS/TTL High-to-Low Transition Time (Figure 4)		2.2	5.0	ns	
RSPos0	Receiver Input Strobe Position for Bit 0 (Figure 18)	f = 65 MHz	0.7	1.1	1.4	ns
RSPos1	Receiver Input Strobe Position for Bit 1		2.9	3.3	3.6	ns
RSPos2	Receiver Input Strobe Position for Bit 2		5.1	5.5	5.8	ns
RSPos3	Receiver Input Strobe Position for Bit 3		7.3	7.7	8.0	ns
RSPos4	Receiver Input Strobe Position for Bit 4		9.5	9.9	10.2	ns
RSPos5	Receiver Input Strobe Position for Bit 5		11.7	12.1	12.4	ns
RSPos6	Receiver Input Strobe Position for Bit 6		13.9	14.3	14.6	ns
RSKM	RxIN Skew Margin (Note 5) (Figure 19)	f = 65 MHz	400		ps	
RCOP	RxCLK OUT Period (Figure 8)	15	T	50	ns	
RCOH	RxCLK OUT High Time (Figure 8)	f = 65 MHz	7.3	8.6	ns	
RCOL	RxCLK OUT Low Time (Figure 8)	f = 65 MHz	3.45	4.9	ns	
RSRC	RxOUT Setup to RxCLK OUT (Figure 8)	f = 65 MHz	2.5	6.9	ns	
RHRC	RxOUT Hold to RxCLK OUT (Figure 8)	f = 65 MHz	2.5	5.7	ns	
RCCD	RxCLK IN to RxCLK OUT Delay 25°C , $V_{\text{CC}} = 3.3\text{V}$ (Figure 10)	5.0	7.1	9.0	ns	
RPLLS	Receiver Phase Lock Loop Set (Figure 12)			10	ms	
RPDD	Receiver Power Down Delay (Figure 16)			1	μs	

Note 5: Receiver Skew Margin is defined as the valid data sampling region at the receiver inputs. This margin takes into account the transmitter pulse positions (min and max) and the receiver input setup and hold time (internal data sampling window - RSPos). This margin allows for LVDS interconnect skew, inter-symbol interference (both dependent on type/length of cable), and clock jitter (less than 250 ps).

AC Timing Diagrams

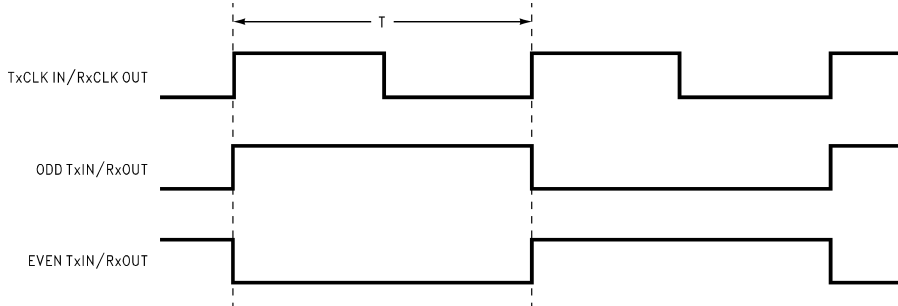

FIGURE 1. "Worst Case" Test Pattern

DS012886-2

AC Timing Diagrams (Continued)

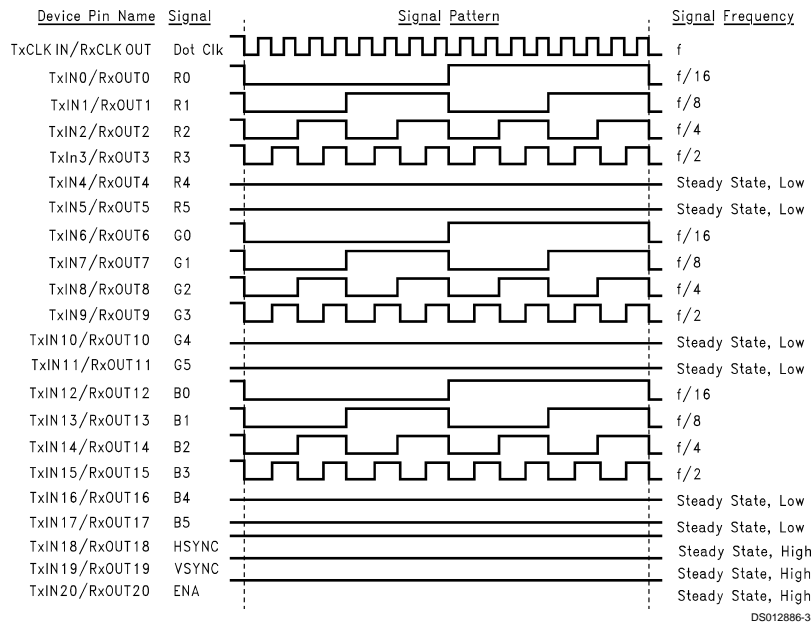

FIGURE 2. "16 Grayscale" Test Pattern (Notes 6, 7, 8, 9)

Note 6: The worst case test pattern produces a maximum toggling of digital circuits, LVDS I/O and CMOS/TTL I/O.

Note 7: The 16 grayscale test pattern tests device power consumption for a "typical" LCD display pattern. The test pattern approximates signal switching needed to produce groups of 16 vertical stripes across the display.

Note 8: Figures 1, 2 show a falling edge data strobe (TxCLK IN/RxCLK OUT).

Note 9: Recommended pin to signal mapping. Customer may choose to define differently.

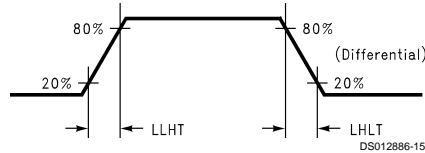

FIGURE 3. DS90C363 (Transmitter) LVDS Output Load and Transition Times

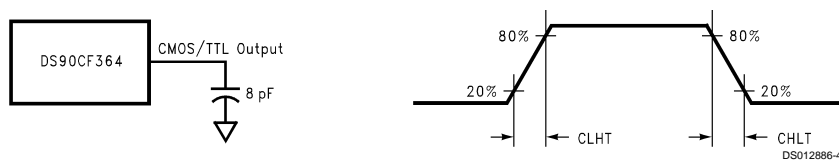

FIGURE 4. DS90CF364 (Receiver) CMOS/TTL Output Load and Transition Times

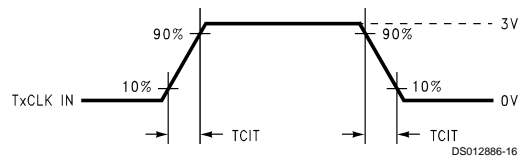
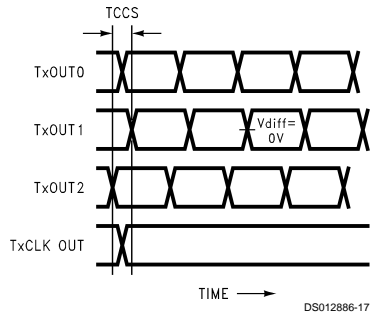

FIGURE 5. DS90C363 (Transmitter) Input Clock Transition Time

AC Timing Diagrams (Continued)



Measurements at $V_{diff}=0V$
 TCCS measured between earliest and latest LVDS edges
 TxCLK Differential Low \rightarrow High Edge

FIGURE 6. DS90C363 (Transmitter) Channel-to-Channel Skew

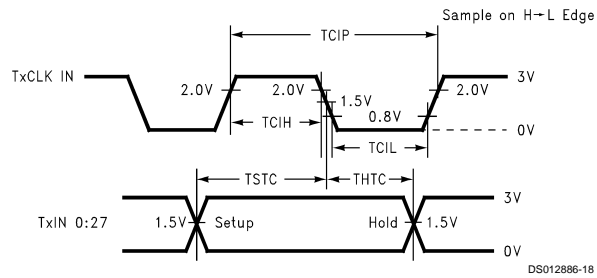

FIGURE 7. DS90C363 (Transmitter) Setup/Hold and High/Low Times

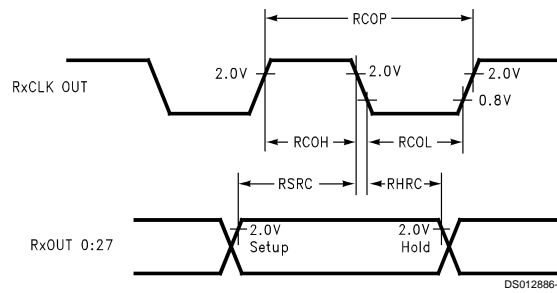

FIGURE 8. DS90CF364 (Receiver) Setup/Hold and High/Low Times

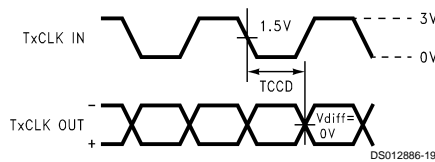

FIGURE 9. DS90C363 (Transmitter) Clock In to Clock Out Delay (Falling Edge Strobe)

AC Timing Diagrams (Continued)

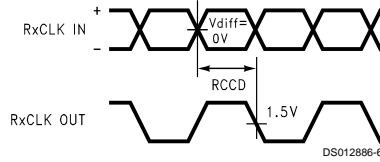

FIGURE 10. DS90CF364 (Receiver) Clock In to Clock Out Delay

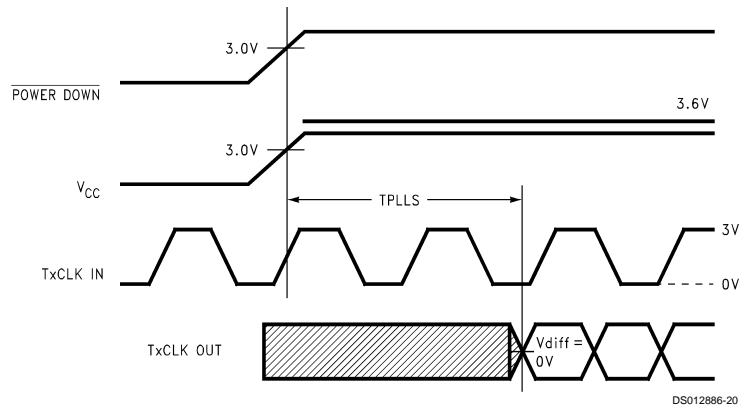

FIGURE 11. DS90C363 (Transmitter) Phase Lock Loop Set Time

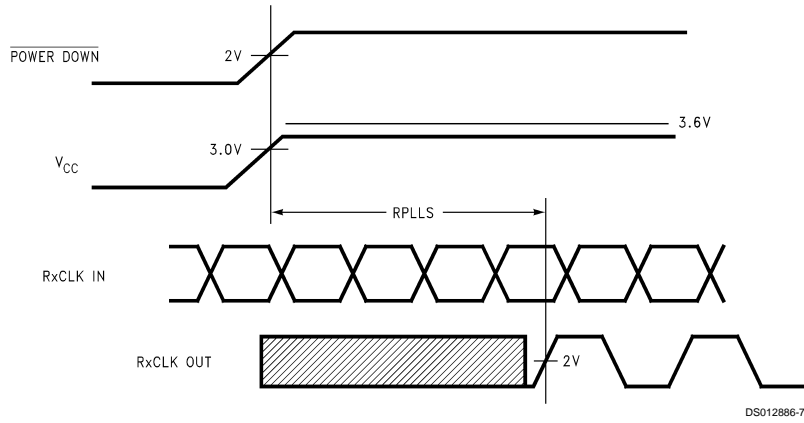

FIGURE 12. DS90CF364 (Receiver) Phase Lock Loop Set Time

AC Timing Diagrams (Continued)

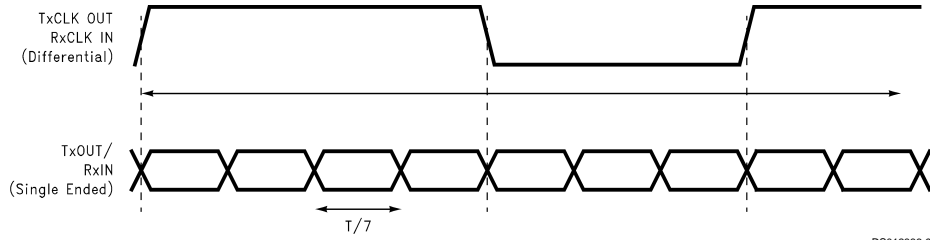

FIGURE 13. Seven Bits of LVDS in One Clock Cycle

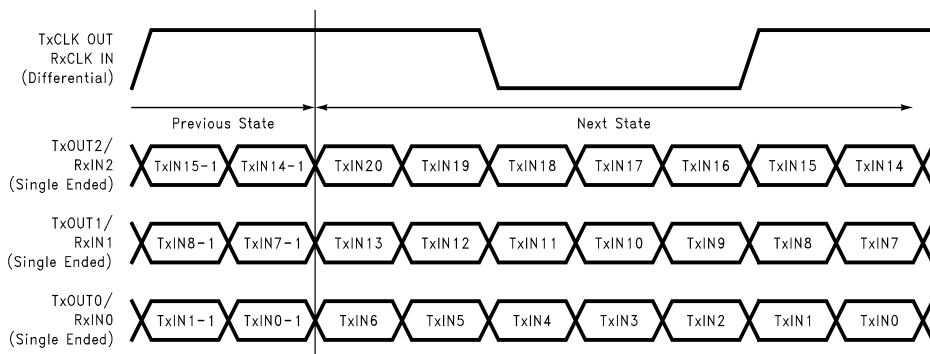

FIGURE 14. 21 Parallel TTL Data Inputs Mapped to LVDS Outputs

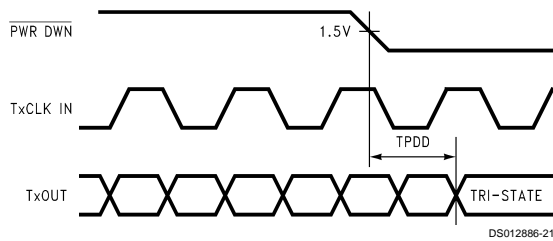

FIGURE 15. Transmitter Power Down Delay

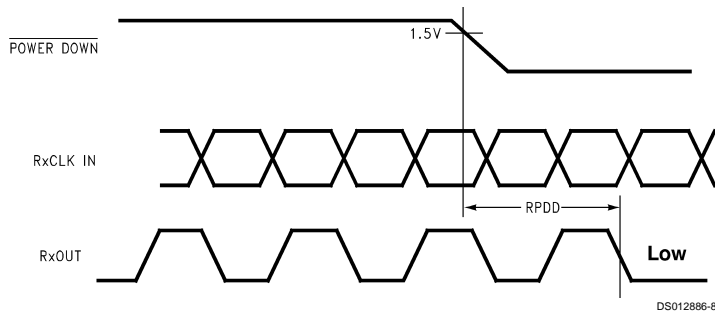
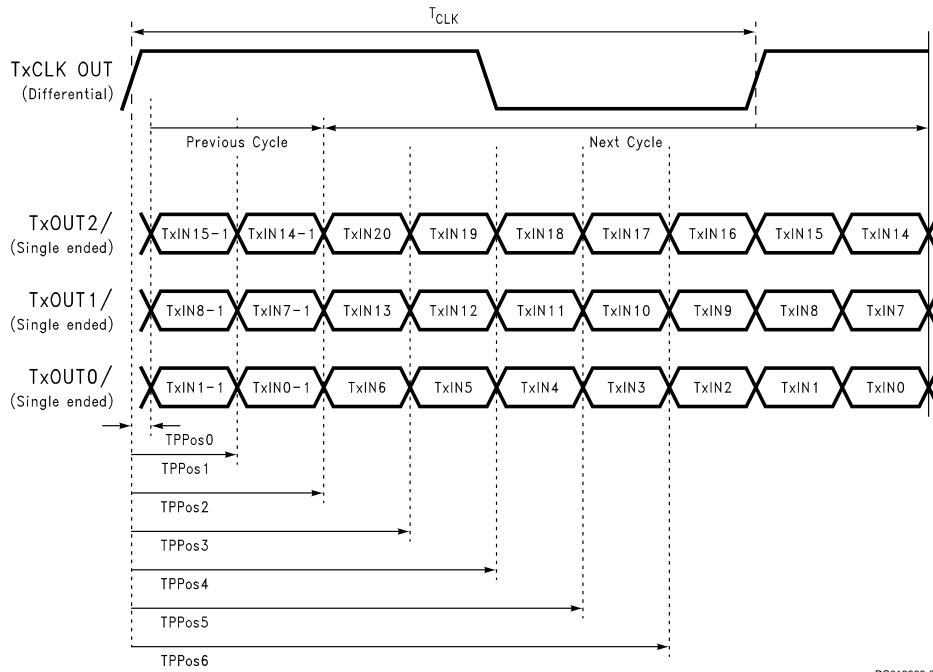

FIGURE 16. Receiver Power Down Delay

AC Timing Diagrams (Continued)



DS012886-22

FIGURE 17. Transmitter LVDS Output Pulse Position Measurement

AC Timing Diagrams (Continued)

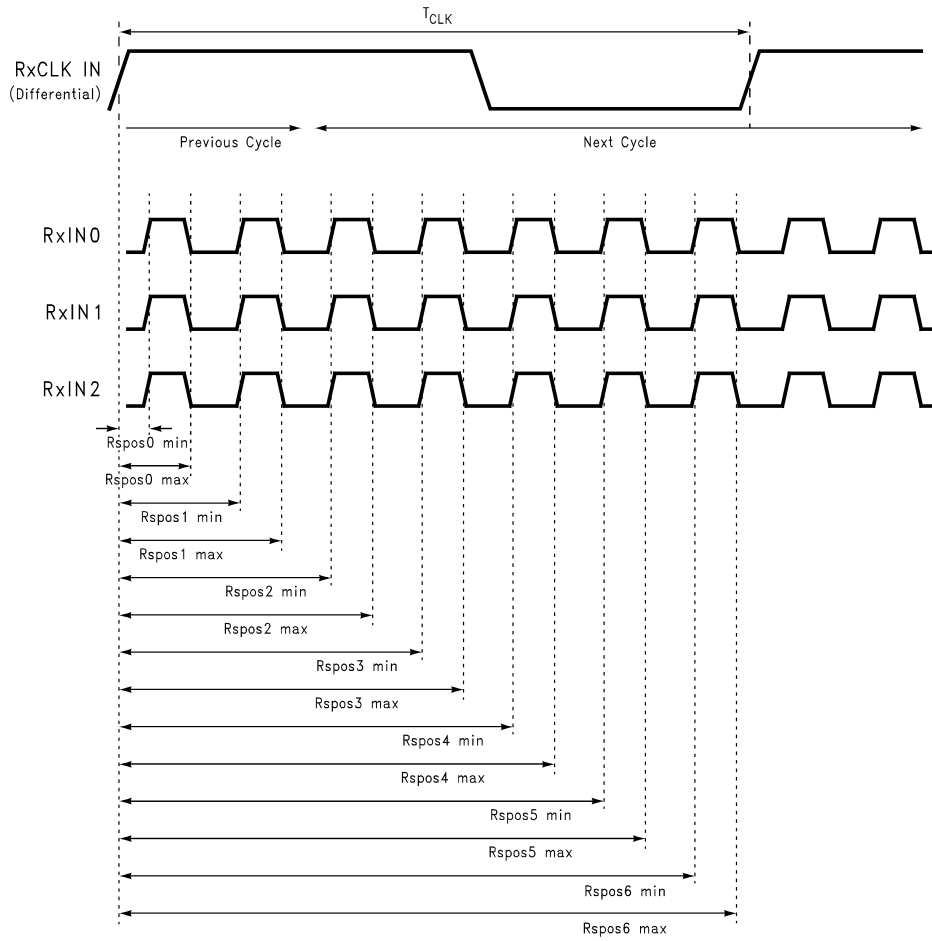

DS012886-25

FIGURE 18. Receiver LVDS Input Strobe Position

AC Timing Diagrams (Continued)

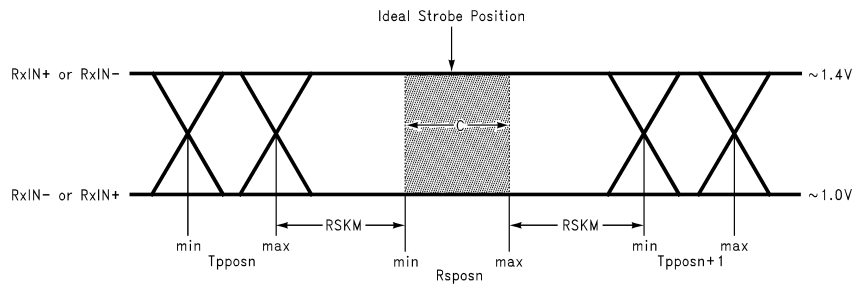

DS012896-11

C — Setup and Hold Time (Internal data sampling window) defined by Rspos (receiver input strobe position) min and max

Tppos — Transmitter output pulse position (min and max)

RSKM = Cable Skew (type, length) + Source Clock Jitter (cycle to cycle) (Note 10) + ISI (Inter-symbol interference) (Note 11)

Cable Skew — typically 10 ps–40 ps per foot, media dependent

Note 10: Cycle-to-cycle jitter is less than 250 ps at 65 MHz.

Note 11: ISI is dependent on interconnect length; may be zero.

FIGURE 19. Receiver LVDS Input Skew Margin

DS90C363 Pin Description—FPD Link Transmitter

Pin Name	I/O	No.	Description
TxIN	I	21	TTL level input. This includes: 6 Red, 6 Green, 6 Blue, and 3 control lines — FPLINE, FPFFRAME and DRDY (also referred to as HSYNC, VSYNC, Data Enable).
TxOUT+	O	3	Positive LVDS differential data output.
TxOUT-	O	3	Negative LVDS differential data output.
FPSHIFT IN	I	1	TTL level clock input. The falling edge acts as data strobe. Pin name TxCLK IN.
R_FB	I	1	Programmable strobe select.
RTxCLK OUT+	O	1	Positive LVDS differential clock output.
TxCLK OUT-	O	1	Negative LVDS differential clock output.
PWR DWN	I	1	TTL level input. When asserted (low input) TRI-STATES the outputs, ensuring low current at power down.
V _{CC}	I	3	Power supply pins for TTL inputs.
GND	I	4	Ground pins for TTL inputs.
PLL V _{CC}	I	1	Power supply pin for PLL.
PLL GND	I	2	Ground pins for PLL.
LVDS V _{CC}	I	1	Power supply pin for LVDS outputs.
LVDS GND	I	3	Ground pins for LVDS outputs.

DS90CF364 Pin Description—FPD Link Receiver

Pin Name	I/O	No.	Description
RxIN+	I	3	Positive LVDS differential data inputs.
RxIN-	I	3	Negative LVDS differential data inputs.
RxOUT	O	21	TTL level data outputs. This includes: 6 Red, 6 Green, 6 Blue, and 3 control lines—FPLINE, FPFRRAME, DRDY (also referred to as HSYNC, VSYNC, Data Enable).
RxCLK IN+	I	1	Positive LVDS differential clock input.
RxCLK IN-	I	1	Negative LVDS differential clock input.
FPSHIFT OUT	O	1	TTL level clock output. The falling edge acts as data strobe. Pin name RxCLK OUT.
PWR DWN	I	1	TTL level input. When asserted (low input) the receiver outputs are low.
V _{CC}	I	4	Power supply pins for TTL outputs.
GND	I	5	Ground pins for TTL outputs.
PLL V _{CC}	I	1	Power supply for PLL.
PLL GND	I	2	Ground pin for PLL.
LVDS V _{CC}	I	1	Power supply pin for LVDS inputs.
LVDS GND	I	3	Ground pins for LVDS inputs.

Applications Information

The DS90C363 and DS90CF364 are backward compatible with the existing 5V FPD Link transmitter/receiver pair (DS90CF563 and DS90CF564). To upgrade from a 5V to a 3.3V system the following must be addressed:

1. Change 5V power supply to 3.3V. Provide this supply to the V_{CC}, LVDS V_{CC} and PLL V_{CC} of both the transmitter and receiver devices. This change may enable the removal of a 5V supply from the system, and power may be supplied from an existing 3V power source.
2. The DS90C363 (transmitter) incorporates a rise/fall strobe select pin. This select function is on pin 14, formerly a V_{CC} connection on the 5V products. When the rise/fall strobe select pin is connected to V_{CC}, the part is configured with a rising edge strobe. In a system currently using a 5V rising edge strobe transmitter (DS90CR563), no layout changes are required to accommodate the new rise/fall select pin on the 3.3V transmitter. The V_{CC} signal may remain at pin 14, and the device will be configured with a rising edge strobe.
When converting from a 5V falling edge transmitter (DS90CF563) to the 3V transmitter a minimal board layout change is necessary. The 3.3V transmitter will not be configured with a falling edge strobe if V_{CC} remains connected to the select pin. To guarantee the 3.3V transmitter functions with a falling edge strobe pin 14 should be connected to ground OR left unconnected. When not connected (left open) and internal pull-down resistor ties pin 14 to ground, thus configuring the transmitter with a falling edge strobe.
3. The DS90C363 transmitter input and control inputs accept 3.3V TTL/CMOS levels. They are not 5V tolerant.

Pin Diagram

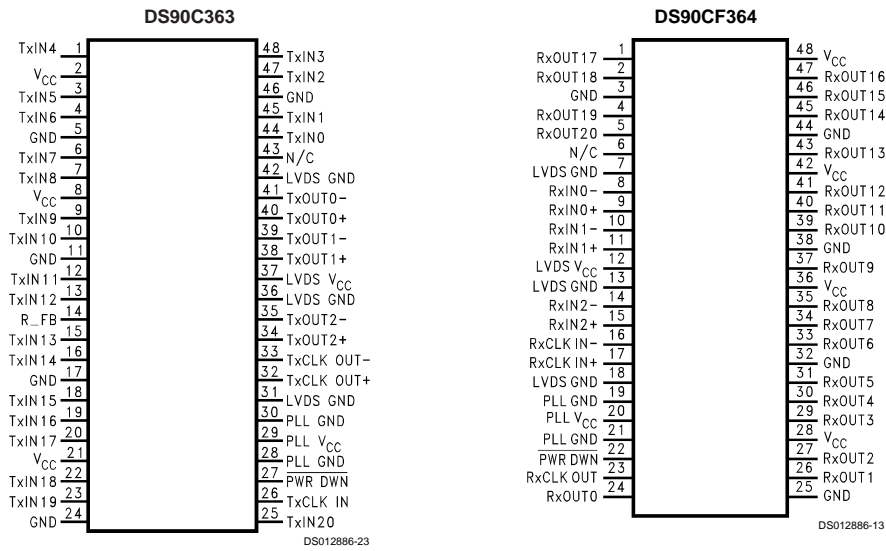
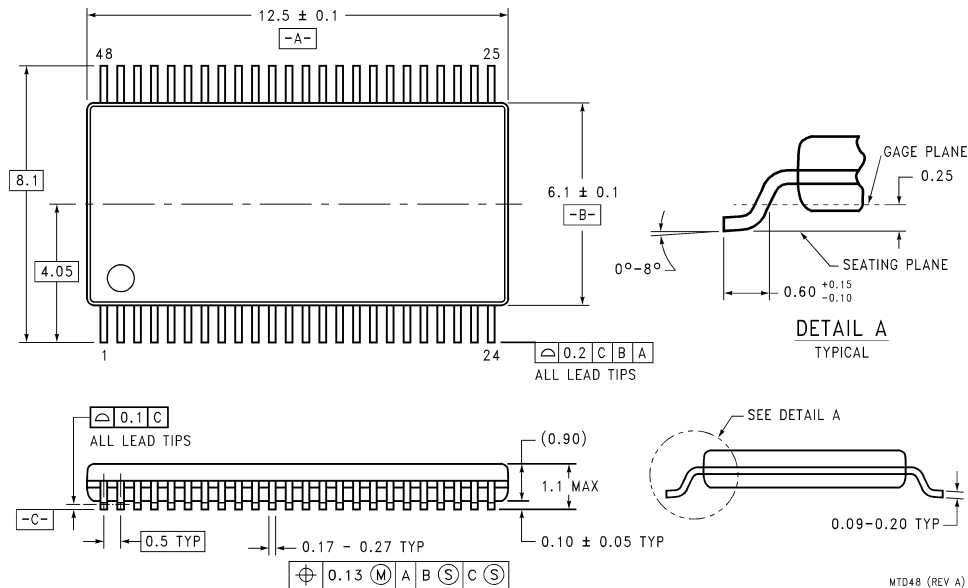

TABLE 1. Programmable Transmitter

Pin	Condition	Strobe Status
R_FB	R_FB = V _{CC}	Rising edge strobe
R_FB	R_FB = GND	Falling edge strobe

DS90C363/DS90CF364 +3.3V Programmable LVDS 18-Bit-Color Flat Panel Display (FPD) Link— 65 MHz

Physical Dimensions inches (millimeters) unless otherwise noted



48-Lead Molded Thin Shrink Small Outline Package, JEDEC
 Dimensions show in millimeters
 Order Number DS90C363MTD and DS90CF364MTD
 NS Package Number MTD48

LIFE SUPPORT POLICY

NATIONAL'S PRODUCTS ARE NOT AUTHORIZED FOR USE AS CRITICAL COMPONENTS IN LIFE SUPPORT DEVICES OR SYSTEMS WITHOUT THE EXPRESS WRITTEN APPROVAL OF THE PRESIDENT AND GENERAL COUNSEL OF NATIONAL SEMICONDUCTOR CORPORATION. As used herein:

1. Life support devices or systems are devices or systems which, (a) are intended for surgical implant into the body, or (b) support or sustain life, and whose failure to perform when properly used in accordance with instructions for use provided in the labeling, can be reasonably expected to result in a significant injury to the user.
2. A critical component is any component of a life support device or system whose failure to perform can be reasonably expected to cause the failure of the life support device or system, or to affect its safety or effectiveness.



National Semiconductor Corporation
 Americas
 Tel: 1-800-272-9959
 Fax: 1-800-737-7018
 Email: support@nsc.com

www.national.com

National Semiconductor Europe

Fax: +49 (0) 1 80-530 85 86
 Email: europe.support@nsc.com
 Deutsch Tel: +49 (0) 1 80-530 85 85
 English Tel: +49 (0) 1 80-532 78 32
 Français Tel: +49 (0) 1 80-532 93 58
 Italiano Tel: +49 (0) 1 80-534 16 80

National Semiconductor Asia Pacific Customer Response Group

Tel: 65-2544466
 Fax: 65-2504466
 Email: sea.support@nsc.com

National Semiconductor Japan Ltd.

Tel: 81-3-5639-7560
 Fax: 81-3-5639-7507

This datasheet has been download from:

www.datasheetcatalog.com

Datasheets for electronics components.