

# DATA SHEET

For a complete data sheet, please also download:

- The IC06 74HC/HCT/HCU/HCMOS Logic Family Specifications
- The IC06 74HC/HCT/HCU/HCMOS Logic Package Information
- The IC06 74HC/HCT/HCU/HCMOS Logic Package Outlines

## **74HC/HCT564**

**Octal D-type flip-flop; positive-edge trigger; 3-state; inverting**

Product specification  
File under Integrated Circuits, IC06

December 1990

# Octal D-type flip-flop; positive-edge trigger; 3-state; inverting

## 74HC/HCT564

### FEATURES

- 3-state inverting outputs for bus oriented applications
- 8-bit positive-edge triggered register
- Common 3-state output enable input
- Independent register and 3-state buffer operation
- Output capability: bus driver
- I<sub>CC</sub> category: MSI

### GENERAL DESCRIPTION

The 74HC/HCT564 are high-speed Si-gate CMOS devices and are pin compatible with low power Schottky TTL (LSTTL). They are specified in compliance with JEDEC standard no. 7A.

The 74HC/HCT564 are octal D-type flip-flops featuring separate D-type inputs for each flip-flop and inverting 3-state outputs for bus oriented applications. A clock (CP) and an output enable ( $\overline{OE}$ ) input are common to all flip-flops.

The 8 flip-flops will store the state of their individual D-inputs that meet the set-up and hold times requirements on the LOW-to-HIGH CP transition.

When  $\overline{OE}$  is LOW, the contents of the 8 flip-flops are available at the outputs.

When  $\overline{OE}$  is HIGH, the outputs go to the high impedance OFF-state. Operation of the  $\overline{OE}$  input does not affect the state of the flip-flops.

The "564" is functionally identical to the "574" but has inverting outputs. The "564" is functionally identical to the "534", but has a different pinning.

### QUICK REFERENCE DATA

GND = 0 V; T<sub>amb</sub> = 25 °C; t<sub>r</sub> = t<sub>f</sub> = 6 ns

SYMBOL	PARAMETER	CONDITIONS	TYPICAL		UNIT
			HC	HCT	
t <sub>PHL</sub> /t <sub>PLH</sub>	propagation delay CP to $\overline{Q}_n$	C <sub>L</sub> = 15 pF; V <sub>CC</sub> = 5 V	15	16	ns
f <sub>max</sub>	maximum clock frequency		127	62	MHz
C <sub>I</sub>	input capacitance		3.5	3.5	pF
C <sub>PD</sub>	power dissipation capacitance per flip-flop	notes 1 and 2	27	27	pF

### Notes

1. C<sub>PD</sub> is used to determine the dynamic power dissipation (P<sub>D</sub> in μW):

$$P_D = C_{PD} \times V_{CC}^2 \times f_i + \sum (C_L \times V_{CC}^2 \times f_o) \text{ where:}$$

f<sub>i</sub> = input frequency in MHz

f<sub>o</sub> = output frequency in MHz

$\sum (C_L \times V_{CC}^2 \times f_o)$  = sum of outputs

C<sub>L</sub> = output load capacitance in pF

V<sub>CC</sub> = supply voltage in V

2. For HC the condition is V<sub>I</sub> = GND to V<sub>CC</sub>; for HCT the condition is V<sub>I</sub> = GND to V<sub>CC</sub> - 1.5 V

### ORDERING INFORMATION

See "74HC/HCT/HCU/HCMOS Logic Package Information".

Octal D-type flip-flop; positive-edge trigger;  
3-state; inverting

74HC/HCT564

PIN DESCRIPTION

PIN NO.	SYMBOL	NAME AND FUNCTION
1	$\overline{OE}$	3-state output enable input (active LOW)
2, 3, 4, 5, 6, 7, 8, 9	D <sub>0</sub> to D <sub>7</sub>	data inputs
10	GND	ground (0 V)
11	CP	clock input (LOW-to-HIGH, edge-triggered)
19, 18, 17, 16, 15, 14, 13, 12	$\overline{Q}_0$ to $\overline{Q}_7$	3-state flip-flop outputs
20	V <sub>CC</sub>	positive supply voltage

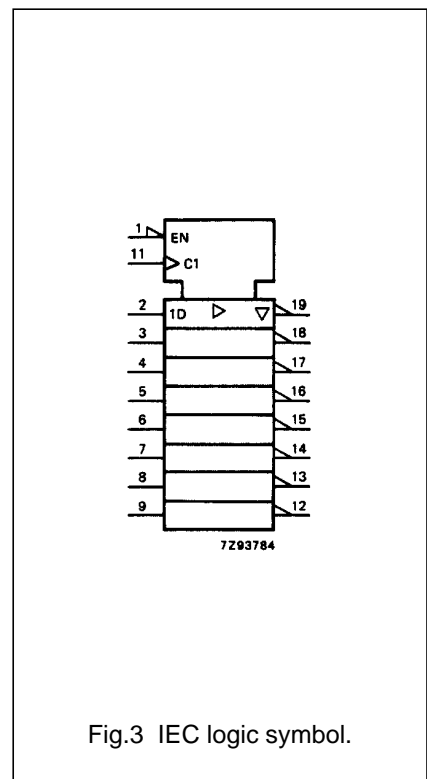
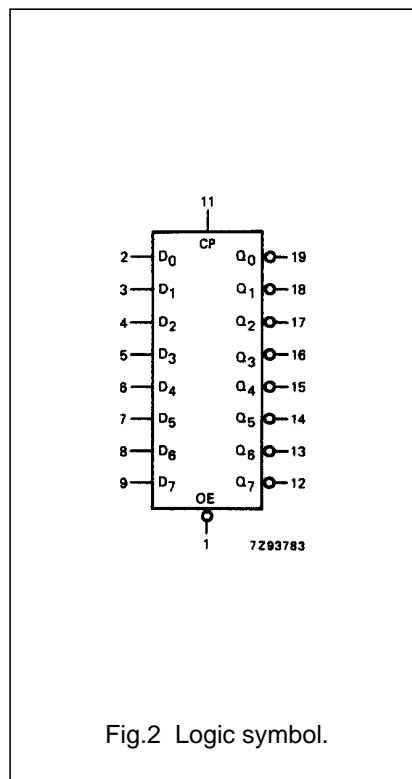
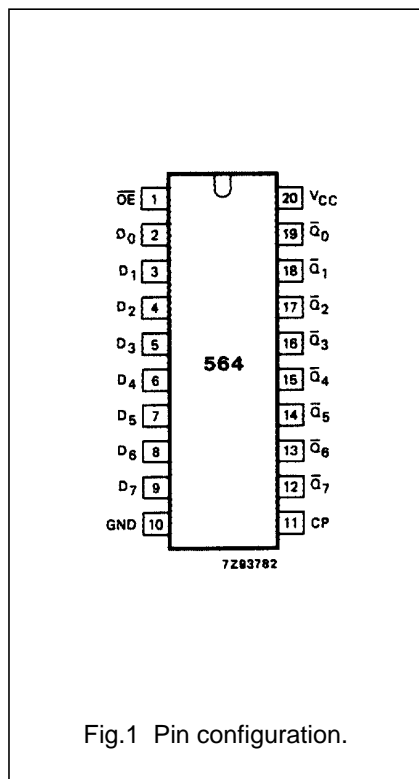

Octal D-type flip-flop; positive-edge trigger;  
3-state; inverting

74HC/HCT564

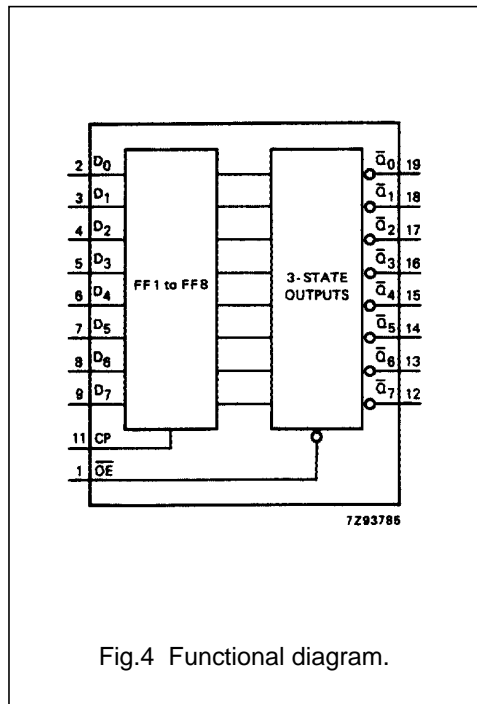

Fig.4 Functional diagram.

FUNCTION TABLE

OPERATING MODES	INPUTS			INTERNAL FLIP-FLOPS	OUTPUTS
	$\overline{OE}$	CP	$D_n$		$\overline{Q}_0$ to $\overline{Q}_7$
load and read register	L	↑	l	L	H
register	L	↑	h	H	L
load register and disable outputs	H	↑	l	L	Z
	H	↑	h	H	Z

Notes

- H = HIGH voltage level  
h = HIGH voltage level one set-up time prior to the LOW-to-HIGH CP transition  
L = LOW voltage level  
l = LOW voltage level one set-up time prior to the LOW-to-HIGH CP transition  
Z = high impedance OFF-state  
↑ = LOW-to-HIGH clock transition

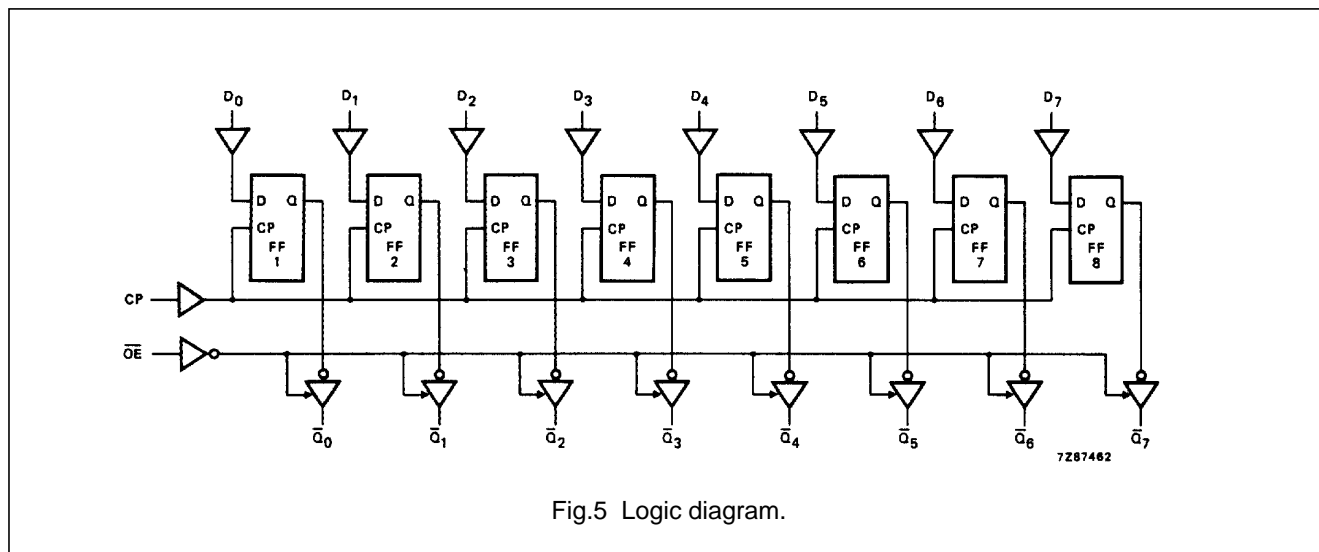

Fig.5 Logic diagram.

# Octal D-type flip-flop; positive-edge trigger; 3-state; inverting

74HC/HCT564

## DC CHARACTERISTICS FOR 74HC

For the DC characteristics see *"74HC/HCT/HCU/HCMOS Logic Family Specifications"*.

Output capability: bus driver

I<sub>CC</sub> category: MSI

## AC CHARACTERISTICS FOR 74HC

GND = 0 V; t<sub>r</sub> = t<sub>f</sub> = 6 ns; C<sub>L</sub> = 50 pF

SYMBOL	PARAMETER	T <sub>amb</sub> (°C)							UNIT	TEST CONDITIONS	
		74HC								V <sub>CC</sub> (V)	WAVEFORMS
		+25			-40 to +85		-40 to +125				
		min.	typ.	max.	min.	max.	min.	max.			
t <sub>PHL</sub> / t <sub>PLH</sub>	propagation delay CP to $\bar{Q}_n$		50 18 14	165 33 28		205 41 35		250 50 43	ns	2.0 4.5 6.0	Fig.6
t <sub>PZH</sub> / t <sub>PZL</sub>	3-state output enable time $\bar{OE}$ to $\bar{Q}_n$		44 16 13	140 28 24		175 35 30		210 42 36	ns	2.0 4.5 6.0	Fig.8
t <sub>PHZ</sub> / t <sub>PLZ</sub>	3-state output disable time $\bar{OE}$ to $\bar{Q}_n$		50 18 14	135 27 23		170 34 29		205 41 35	ns	2.0 4.5 6.0	Fig.8
t <sub>THL</sub> / t <sub>TLH</sub>	output transition time		14 5 4	60 12 10		75 15 13		90 18 15	ns	2.0 4.5 6.0	Fig.6
t <sub>W</sub>	clock pulse width HIGH or LOW	80 16 14	14 5 4		100 20 17		120 24 20		ns	2.0 4.5 6.0	Fig.6
t <sub>SU</sub>	set-up time D <sub>n</sub> to CP	60 12 10	6 2 2		75 15 13		90 18 15		ns	2.0 4.5 6.0	Fig.7
t <sub>H</sub>	hold time D <sub>n</sub> to CP	5 5 5	0 0 0		5 5 5		5 5 5		ns	2.0 4.5 6.0	Fig.7
f <sub>max</sub>	maximum clock pulse frequency	6.0 30 35	38 115 137		4.8 24 28		4.0 20 24		MHz	2.0 4.5 6.0	Fig.6

# Octal D-type flip-flop; positive-edge trigger; 3-state; inverting

74HC/HCT564

## DC CHARACTERISTICS FOR 74HCT

For the DC characteristics see *"74HC/HCT/HCU/HCMOS Logic Family Specifications"*.

Output capability: bus driver

I<sub>CC</sub> category: MSI

### Note to HCT types

The value of additional quiescent supply current ( $\Delta I_{CC}$ ) for a unit load of 1 is given in the family specifications. To determine  $\Delta I_{CC}$  per input, multiply this value by the unit load coefficient shown in the table below.

INPUT	UNIT LOAD COEFFICIENT
$\overline{OE}$	0.80
D <sub>0</sub> to D <sub>7</sub>	0.25
CP	1.00

## AC CHARACTERISTICS FOR 74HCT

GND = 0 V; t<sub>r</sub> = t<sub>f</sub> = 6 ns; C<sub>L</sub> = 50 pF

SYMBOL	PARAMETER	T <sub>amb</sub> (°C)						UNIT	TEST CONDITIONS		
		74HCT							V <sub>CC</sub> (V)	WAVEFORMS	
		+25			-40 to +85		-40 to +125				
		min.	typ.	max.	min.	max.	min.				max.
t <sub>PHL</sub> / t <sub>PLH</sub>	propagation delay CP to $\overline{Q}_n$		19	35		44		53	ns	4.5	Fig.6
t <sub>PZH</sub> / t <sub>PZL</sub>	3-state output enable time OE to $\overline{Q}_n$		19	35		44		53	ns	4.5	Fig.8
t <sub>PHZ</sub> / t <sub>PLZ</sub>	3-state output disable time $\overline{OE}$ to $\overline{Q}_n$		19	30		38		45	ns	4.5	Fig.8
t <sub>THL</sub> / t <sub>TLH</sub>	output transition time		5	12		15		18	ns	4.5	Fig.6
t <sub>W</sub>	clock pulse width HIGH or LOW	18	8		23		27		ns	4.5	Fig.6
t <sub>SU</sub>	set-up time D <sub>n</sub> to CP	12	3		15		18		ns	4.5	Fig.7
t <sub>H</sub>	hold time D <sub>n</sub> to CP	3	-2		3		3		ns	4.5	Fig.7
f <sub>max</sub>	maximum clock pulse frequency	27	56		22		18		MHz	4.5	Fig.6

Octal D-type flip-flop; positive-edge trigger;  
3-state; inverting

74HC/HCT564

AC WAVEFORMS

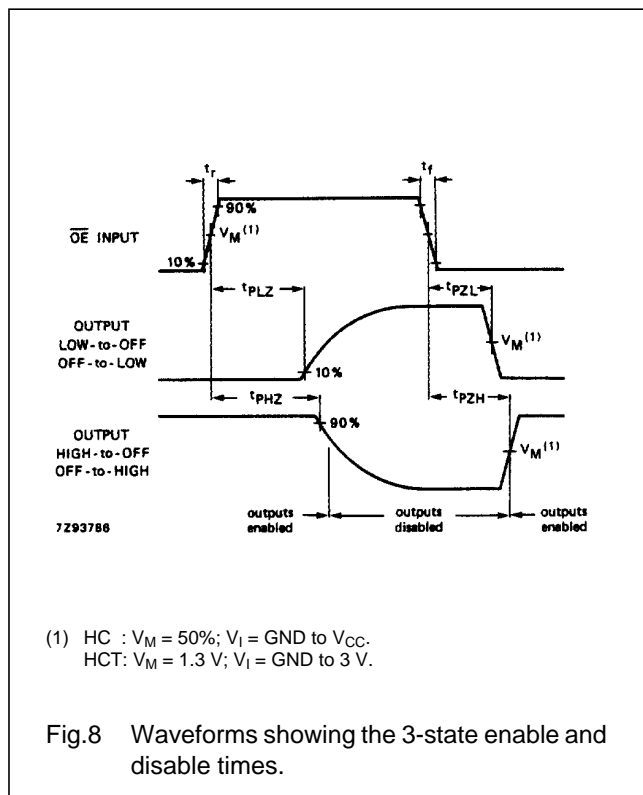
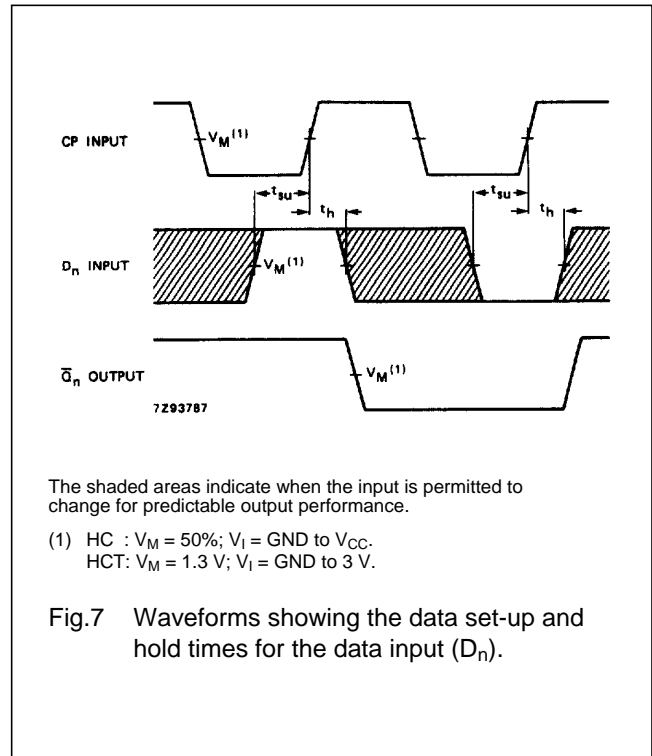
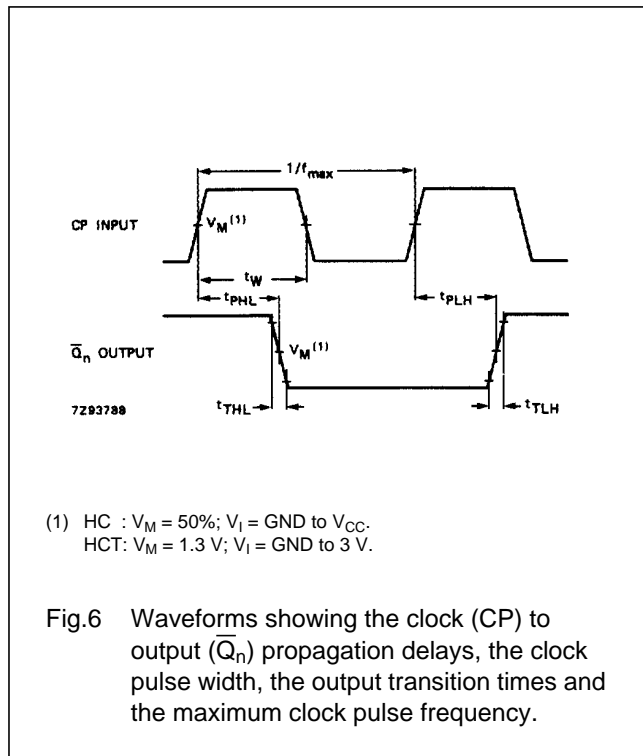

PACKAGE OUTLINES

See "74HC/HCT/HCU/HCMOS Logic Package Outlines".

This datasheet has been download from:

[www.datasheetcatalog.com](http://www.datasheetcatalog.com)

Datasheets for electronics components.