

SN54LS422, SN54LS423, SN74LS422, SN74LS423 RETRIGGERABLE MONOSTABLE MULTIVIBRATORS

SDLS175 D2536, JANUARY 1980 — REVISED MARCH 1988

- Will Not Trigger from Clear
- D-C Triggered from Active-High or Active-Low Gated Logic Inputs
- Retriggerable for Very Long Output Pulses, Up to 100% Duty Cycle
- Overriding Clear Terminates Output Pulse
- 'LS422 Has Internal Timing Resistor

description

The 'LS422 and 'LS423 are identical to 'LS122 and 'LS123 except they cannot be triggered via clear.

These d-c triggered multivibrators feature output-pulse-width control by three methods. The basic pulse time is programmed by selection of external resistance and capacitance values (see typical application data). The 'LS422 contains an internal timing resistor that allows the circuits to be used with only an external capacitor, if so desired. Once triggered, the basic pulse width may be extended by retriggering the gated low-level-active (A) or high-level-active (B) inputs, or be reduced by use of the overriding clear. Figure 1 illustrates pulse control by retriggering and early clear.

The 'LS422 and 'LS423 have enough Schmitt hysteresis to ensure jitter-free triggering from the B input with transition rates as slow as 0.1 millivolt per nanosecond. The 'LS422 R_{int} is nominally 10 k ohms.

The SN54LS422 and SN54LS423 are characterized for operation over the full military temperature range of -55°C to 125°C . The SN74LS422 and SN74LS423 are characterized for operation from 0°C to 70°C .

SN54LS423 . . . J OR W PACKAGE
SN74LS423 . . . D OR N PACKAGE
(TOP VIEW) (SEE NOTES 1 THRU 4)

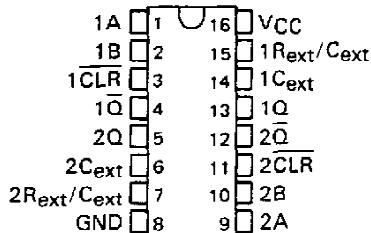

SN54LS422 . . . J OR W PACKAGE
SN74LS422 . . . D OR N PACKAGE
(TOP VIEW) (SEE NOTES 1 THRU 4)

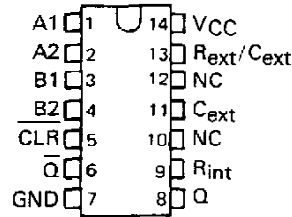

SN54LS422 . . . FK PACKAGE
(TOP VIEW) (SEE NOTES 1 THRU 4)

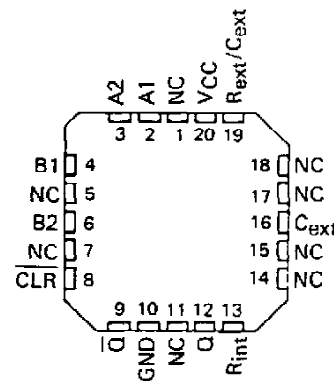

SN54LS423 . . . FK PACKAGE
(TOP VIEW) (SEE NOTES 1 THRU 4)

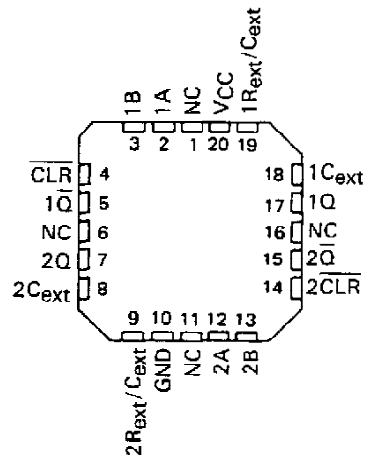

- NOTES: 1. An external timing capacitor may be connected between C_{ext} and R_{ext}/C_{ext} (positive).
 2. To use the internal timing resistor of 'LS422, connect R_{int} to V_{CC} .
 3. For improved pulse width accuracy and repeatability, connect an external resistor between R_{ext}/C_{ext} and V_{CC} with R_{int} open-circuited.
 4. To obtain variable pulse widths, connect an external variable resistance between R_{int} or R_{ext}/C_{ext} and V_{CC} .

PRODUCTION DATA documents contain information current as of publication date. Products conform to specifications per the terms of Texas Instruments standard warranty. Production processing does not necessarily include testing of all parameters.

TEXAS
INSTRUMENTS

POST OFFICE BOX 655012 • DALLAS, TEXAS 75265

SN54LS422, SN54LS423, SN74LS422, SN74LS423 RETRIGGERABLE MONOSTABLE MULTIVIBRATORS

description (continued)

LS422 FUNCTION TABLE							LS423 FUNCTION TABLE					
INPUTS						OUTPUTS		INPUTS			OUTPUTS	
CLEAR	A1	A2	B1	B2	Q	\bar{Q}	CLEAR	A	B	Q	\bar{Q}	
L	X	X	X	X	L	H	L	X	X	L	H	
X	H	H	X	X	L↑	H↑	X	H	X	L↑	H↑	
X	X	X	L	X	L↑	H↑	X	X	L	L↑	H↑	
X	X	X	X	L	L↑	H↑	H	L	↑	↓	↓	
H	L	X	↑	H	↓	↓	H	X	L	↑	H	
H	L	X	H	↑	↓	↓	H	X	L	H	↑	
H	X	L	↑	H	↓	↓	X	H	↓	H	H	
H	X	L	H	↑	↓	↓	X	↓	↓	H	H	
H	↓	↓	H	H	↓	↓	H	↓	H	H	H	
H	↓	H	H	H	↓	↓	H	↓	H	H	H	

† These lines of the functional tables assume that the indicated steady-state conditions at the A and B inputs have been set up long enough to complete any pulse started before the set up.

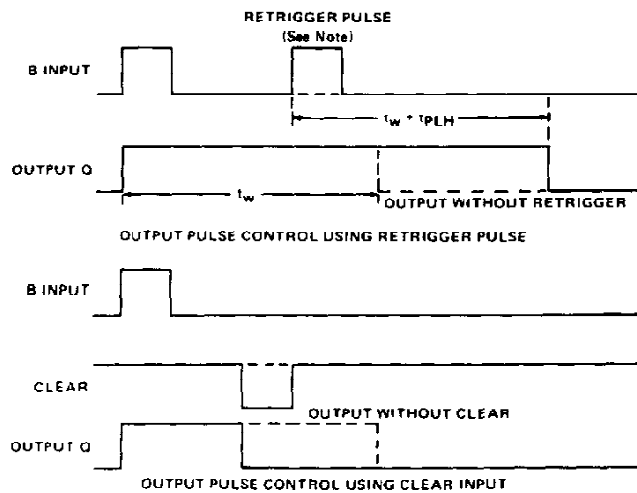

NOTE: Retrigger pulses starting before $0.22 C_{ext}$ (in picofrads) nanoseconds after the initial trigger pulse will be ignored and the output pulse will remain unchanged.

FIGURE 1—TYPICAL INPUT/OUTPUT PULSES

SN54LS422, SN54LS423, SN74LS422, SN74LS423 RETRIGGERABLE MONOSTABLE MULTIVIBRATORS

logic symbols†

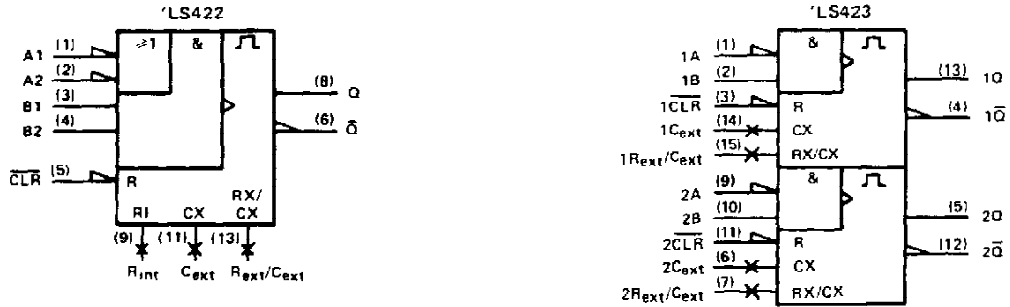

† These symbols are in accordance with ANSI/IEEE Std 91-1984 and IEC Publication 617-12.

logic diagrams (positive logic)

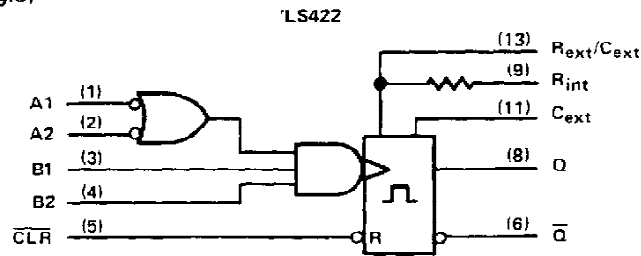

R_{int} is nominally 10 k ohms

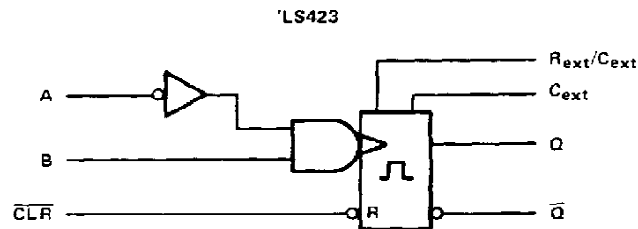

Pin numbers shown are for D, J, N, and W packages.

schematics of inputs and outputs

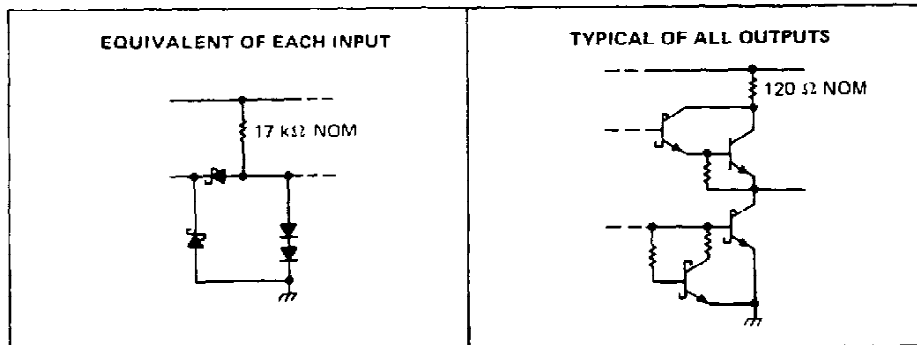

SN54LS422, SN54LS423, SN74LS422, SN74LS423 RETRIGGERABLE MONOSTABLE MULTIVIBRATORS

recommended operating conditions

	SN54LS*			SN74LS*			UNIT
	MIN	NOM	MAX	MIN	NOM	MAX	
Supply voltage, V_{CC}	4.5	5	5.5	4.75	5	5.25	V
High-level output current, I_{OH}			-400			-400	μ A
Low-level output current, I_{OL}			4			8	mA
Pulse width, t_W	40			40			ns
External timing resistance, R_{ext}	5		180	5		260	k Ω
External capacitance, C_{ext}	No restriction			No restriction			
Wiring capacitance at R_{ext}/C_{ext} terminal	50			50			pF
Operating free-air temperature, T_A	-55		125	0		70	$^{\circ}$ C

electrical characteristics over recommended operating free-air temperature range (unless otherwise noted)

PARAMETER	TEST CONDITIONS†	SN54LS*			SN74LS*			UNIT	
		MIN	TYP‡	MAX	MIN	TYP‡	MAX		
V_{IH} High-level input voltage		2			2			V	
V_{IL} Low-level input voltage				0.7			0.8	V	
V_{IK} Input clamp voltage	$V_{CC} = \text{MIN}$, $I_I = -18 \text{ mA}$			-1.5			-1.5	V	
V_{OH} High-level output voltage	$V_{CC} = \text{MIN}$, $V_{IH} = 2 \text{ V}$, $V_{IL} = V_{IL \text{ max}}$, $I_{OH} = 400 \mu\text{A}$	2.5	3.5		2.7	3.5		V	
V_{OL} Low-level output voltage	$V_{CC} = \text{MIN}$, $V_{IH} = 2 \text{ V}$, $V_{IL} = V_{IL \text{ max}}$			0.25	0.4		0.25	0.4	V
							0.35	0.5	
I_I Input current at maximum input voltage	$V_{CC} = \text{MAX}$, $V_I = 7 \text{ V}$			0.1			0.1	mA	
I_{IH} High-level input current	$V_{CC} = \text{MAX}$, $V_I = 2.7 \text{ V}$			20			20	μ A	
I_{IL} Low-level input current	$V_{CC} = \text{MAX}$, $V_I = 0.4 \text{ V}$			-0.4			-0.4	mA	
I_{OS} Short-circuit output current §	$V_{CC} = \text{MAX}$	-20		-100	-20		-100	mA	
I_{CC} Supply current (quiescent or triggered)	$V_{CC} = \text{MAX}$, See Note 6			6	11		6	11	mA
				12	20		12	20	

† For conditions shown as MIN or MAX, use the appropriate value specified under recommended operating conditions.

‡ All typical values are at $V_{CC} = 5 \text{ V}$, $T_A = 25^{\circ}\text{C}$.

§ Not more than one output should be shorted at a time and duration of the short-circuit should not exceed one second.

NOTES: 5. To measure V_{OH} at Q, V_{OL} at \bar{Q} , or I_{OS} at Q, ground R_{ext}/C_{ext} , apply 2 V to B and clear, and pulse A from 2 V to 0 V.
6. With all outputs open and 4.5 V applied to all data and clear inputs, I_{CC} is measured after a momentary ground, then 4.5 V, is applied to clock.

switching characteristics, $V_{CC} = 5 \text{ V}$, $T_A = 25^{\circ}\text{C}$, see note 7

PARAMETER¶	FROM (INPUT)	TO (OUTPUT)	TEST CONDITIONS	MIN	TYP	MAX	UNIT
t_{PLH}	A	Q	$C_{ext} = 0$, $R_{ext} = 5 \text{ k}\Omega$, $C_L = 15 \text{ pF}$, $R_L = 2 \text{ k}\Omega$		23	33	ns
	B	Q			23	44	
t_{PHL}	A	\bar{Q}			32	45	ns
	B	\bar{Q}			34	56	
t_{PHL}	Clear	Q			20	27	ns
t_{PLH}	Clear	\bar{Q}			28	45	ns
$t_{wQ}(\text{min})$	A or B	Q		116	200	ns	
t_{wQ}	A or B	Q	$C_{ext} = 1000 \text{ pF}$, $R_{ext} = 10 \text{ k}\Omega$, $C_L = 15 \text{ pF}$, $R_L = 2 \text{ k}\Omega$	4	4.5	5	μ s

¶ t_{wQ} = width of pulse output Q.

NOTE 7: Load circuits and voltage waveforms are shown in Section 1.

TEXAS
INSTRUMENTS

POST OFFICE BOX 655012 • DALLAS, TEXAS 75265

SN54LS422, SN54LS423, SN74LS422, SN74LS423 RETRIGGERABLE MONOSTABLE MULTIVIBRATORS

TYPICAL APPLICATION DATA FOR 'LS422, 'LS423†

The basic output pulse width is essentially determined by the values of external capacitance and timing resistance. For pulse widths when $C_{ext} \leq 1000$ pF, use Figure 3. For C_{ext} between 0.1 nF and 1 μ F, the pulse width may be defined as:

$$t_w \approx K \cdot R_T \cdot C_{ext}$$

with K obtained from Figure 4.

When $C_{ext} \geq 1$ μ F, the output pulse width is defined as:

$$t_w \approx 0.33 \cdot R_T \cdot C_{ext}$$

Where

R_T is in kilohms (internal or external timing resistance)

C_{ext} is in pF

t_w is in nanoseconds

For maximum noise immunity, system ground should be applied to the C_{ext} node, even though the C_{ext} node is already tied to the ground lead internally. Due to the timing scheme used by the 'LS422 and 'LS423, a switching diode is not required to prevent reverse biasing when using electrolytic capacitors.

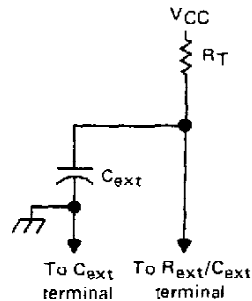

TIMING COMPONENT CONNECTIONS
FIGURE 2

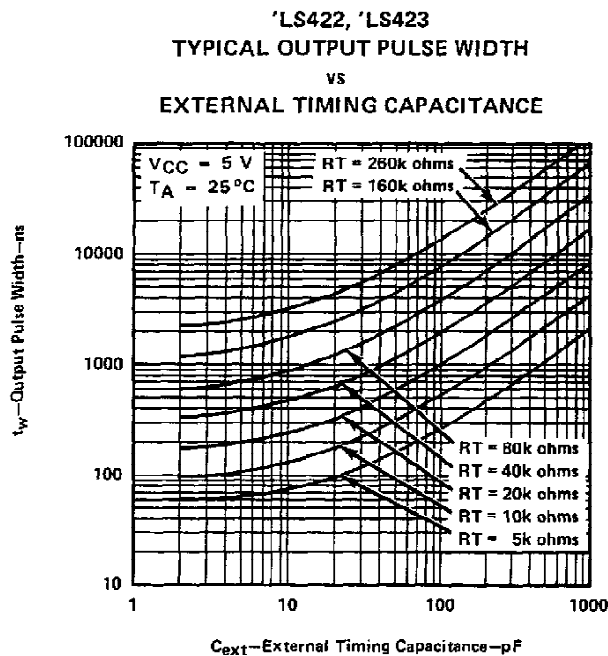

† This value of resistance exceeds the maximum recommended for use over the full temperature range of the SN54LS circuits.

FIGURE 3

TEXAS
INSTRUMENTS

POST OFFICE BOX 655012 • DALLAS, TEXAS 75265

SN54LS422, SN54LS423, SN74LS422, SN74LS423 RETRIGGERABLE MONOSTABLE MULTIVIBRATORS

TYPICAL APPLICATION DATA FOR 'LS422, 'LS423 †

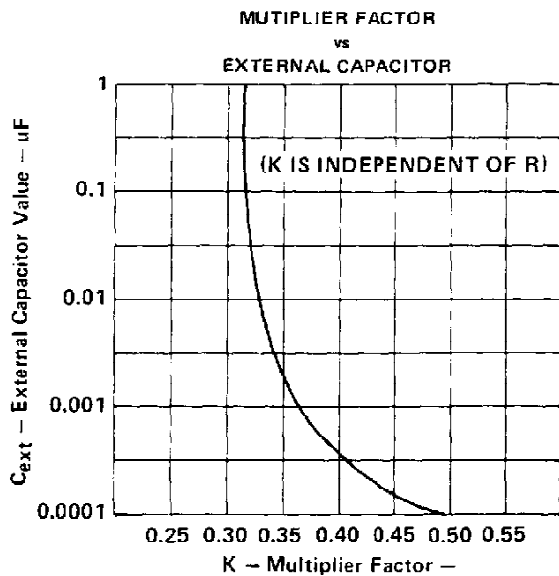

FIGURE 4

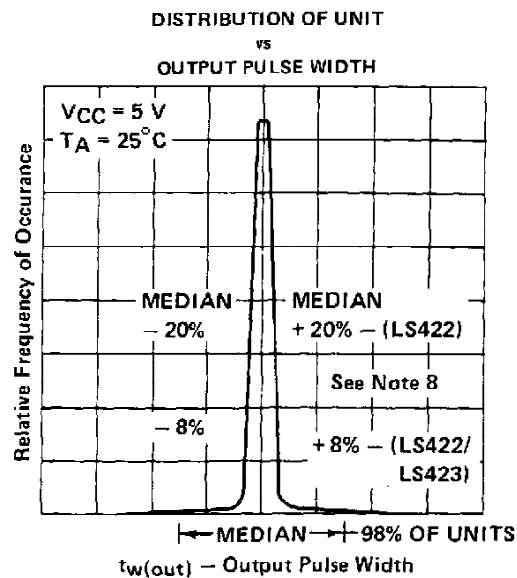

FIGURE 5

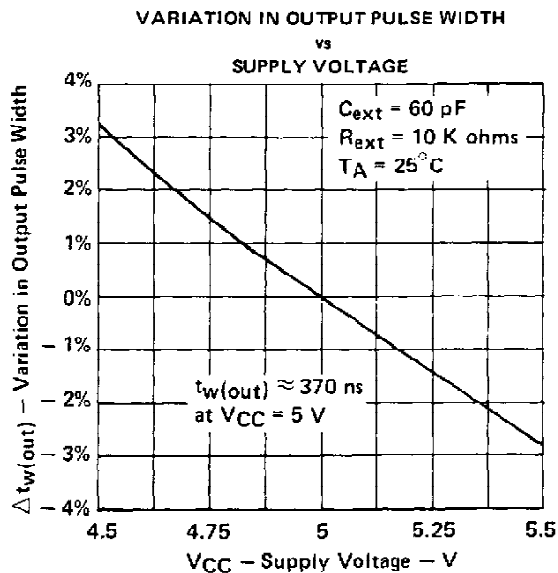

FIGURE 6

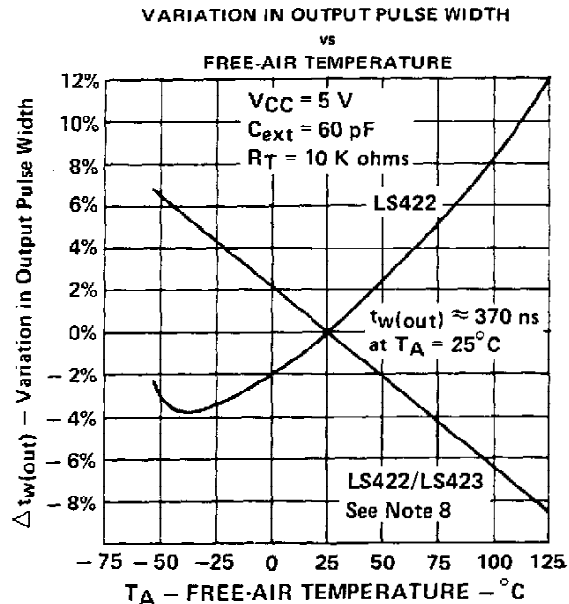

FIGURE 7

NOTE 8: For the LS422, the internal timing resistor, R_{int} was used. For the LS422/423, an external timing resistor was used for R_T .
† Data for temperatures below $0^\circ C$ and above $70^\circ C$ and for supply voltages below 4.75 V and above 5.25 V are applicable for SN54LS422 and SN54LS423 only.

TEXAS
INSTRUMENTS

POST OFFICE BOX 655012 • DALLAS, TEXAS 75265

IMPORTANT NOTICE

Texas Instruments (TI) reserves the right to make changes to its products or to discontinue any semiconductor product or service without notice, and advises its customers to obtain the latest version of relevant information to verify, before placing orders, that the information being relied on is current.

TI warrants performance of its semiconductor products and related software to the specifications applicable at the time of sale in accordance with TI's standard warranty. Testing and other quality control techniques are utilized to the extent TI deems necessary to support this warranty. Specific testing of all parameters of each device is not necessarily performed, except those mandated by government requirements.

Certain applications using semiconductor products may involve potential risks of death, personal injury, or severe property or environmental damage ("Critical Applications").

TI SEMICONDUCTOR PRODUCTS ARE NOT DESIGNED, INTENDED, AUTHORIZED, OR WARRANTED TO BE SUITABLE FOR USE IN LIFE-SUPPORT APPLICATIONS, DEVICES OR SYSTEMS OR OTHER CRITICAL APPLICATIONS.

Inclusion of TI products in such applications is understood to be fully at the risk of the customer. Use of TI products in such applications requires the written approval of an appropriate TI officer. Questions concerning potential risk applications should be directed to TI through a local SC sales office.

In order to minimize risks associated with the customer's applications, adequate design and operating safeguards should be provided by the customer to minimize inherent or procedural hazards.

TI assumes no liability for applications assistance, customer product design, software performance, or infringement of patents or services described herein. Nor does TI warrant or represent that any license, either express or implied, is granted under any patent right, copyright, mask work right, or other intellectual property right of TI covering or relating to any combination, machine, or process in which such semiconductor products or services might be or are used.

IMPORTANT NOTICE

Texas Instruments (TI) reserves the right to make changes to its products or to discontinue any semiconductor product or service without notice, and advises its customers to obtain the latest version of relevant information to verify, before placing orders, that the information being relied on is current.

TI warrants performance of its semiconductor products and related software to the specifications applicable at the time of sale in accordance with TI's standard warranty. Testing and other quality control techniques are utilized to the extent TI deems necessary to support this warranty. Specific testing of all parameters of each device is not necessarily performed, except those mandated by government requirements.

Certain applications using semiconductor products may involve potential risks of death, personal injury, or severe property or environmental damage ("Critical Applications").

TI SEMICONDUCTOR PRODUCTS ARE NOT DESIGNED, INTENDED, AUTHORIZED, OR WARRANTED TO BE SUITABLE FOR USE IN LIFE-SUPPORT APPLICATIONS, DEVICES OR SYSTEMS OR OTHER CRITICAL APPLICATIONS.

Inclusion of TI products in such applications is understood to be fully at the risk of the customer. Use of TI products in such applications requires the written approval of an appropriate TI officer. Questions concerning potential risk applications should be directed to TI through a local SC sales office.

In order to minimize risks associated with the customer's applications, adequate design and operating safeguards should be provided by the customer to minimize inherent or procedural hazards.

TI assumes no liability for applications assistance, customer product design, software performance, or infringement of patents or services described herein. Nor does TI warrant or represent that any license, either express or implied, is granted under any patent right, copyright, mask work right, or other intellectual property right of TI covering or relating to any combination, machine, or process in which such semiconductor products or services might be or are used.

IMPORTANT NOTICE

Texas Instruments and its subsidiaries (TI) reserve the right to make changes to their products or to discontinue any product or service without notice, and advise customers to obtain the latest version of relevant information to verify, before placing orders, that information being relied on is current and complete. All products are sold subject to the terms and conditions of sale supplied at the time of order acknowledgement, including those pertaining to warranty, patent infringement, and limitation of liability.

TI warrants performance of its semiconductor products to the specifications applicable at the time of sale in accordance with TI's standard warranty. Testing and other quality control techniques are utilized to the extent TI deems necessary to support this warranty. Specific testing of all parameters of each device is not necessarily performed, except those mandated by government requirements.

CERTAIN APPLICATIONS USING SEMICONDUCTOR PRODUCTS MAY INVOLVE POTENTIAL RISKS OF DEATH, PERSONAL INJURY, OR SEVERE PROPERTY OR ENVIRONMENTAL DAMAGE ("CRITICAL APPLICATIONS"). TI SEMICONDUCTOR PRODUCTS ARE NOT DESIGNED, AUTHORIZED, OR WARRANTED TO BE SUITABLE FOR USE IN LIFE-SUPPORT DEVICES OR SYSTEMS OR OTHER CRITICAL APPLICATIONS. INCLUSION OF TI PRODUCTS IN SUCH APPLICATIONS IS UNDERSTOOD TO BE FULLY AT THE CUSTOMER'S RISK.

In order to minimize risks associated with the customer's applications, adequate design and operating safeguards must be provided by the customer to minimize inherent or procedural hazards.

TI assumes no liability for applications assistance or customer product design. TI does not warrant or represent that any license, either express or implied, is granted under any patent right, copyright, mask work right, or other intellectual property right of TI covering or relating to any combination, machine, or process in which such semiconductor products or services might be or are used. TI's publication of information regarding any third party's products or services does not constitute TI's approval, warranty or endorsement thereof.

This datasheet has been download from:

www.datasheetcatalog.com

Datasheets for electronics components.