

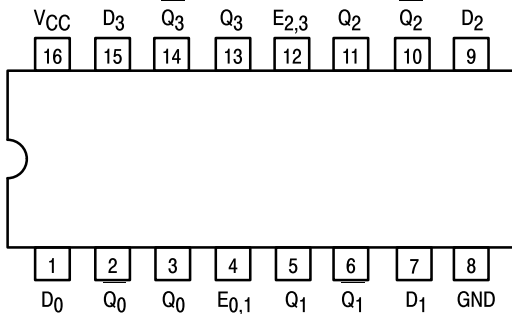

4-BIT D LATCH

The SN54/74LS375 is a 4-Bit D-Type Latch for use as temporary storage for binary information between processing limits and input/output or indicator units. When the Enable (E) is HIGH, information present at the D input will be transferred to the Q output and, if E is HIGH, the Q output will follow the input. When E goes LOW, the information present at the D input prior to its setup time will be retained at the Q outputs.

CONNECTION DIAGRAM DIP (TOP VIEW)



NOTE:
The Flatpak version has the same pinouts (Connection Diagram) as the Dual In-Line Package.

TRUTH TABLE (Each latch)

t_n	t_{n+1}
D	Q
H	H
L	L

NOTES:
 t_n = bit time before enable negative-going transition.
 t_{n+1} = bit time after enable negative-going transition.

PIN NAMES

D_1-D_4	Data Inputs
E_{0-1}	Enable Input Latches 0, 1
E_{2-3}	Enable Input Latches 2, 3
Q_1-Q_4	Latch Outputs (Note b)
Q_1-Q_4	Complimentary Latch Outputs (Note b)

LOADING (Note a)

HIGH	LOW
0.5 U.L.	0.25 U.L.
2.0 U.L.	1.0 U.L.
2.0 U.L.	1.0 U.L.
10 U.L.	5 (2.5) U.L.
10 U.L.	5 (2.5) U.L.

NOTES:

- a) 1 TTL Unit Load (U.L.) = 40 μ A HIGH/1.6 mA LOW.
b) The Output LOW drive factor is 25 U.L. for Military (54) and 5 U.L. for Commercial (74) Temperature Ranges.

LOGIC DIAGRAM

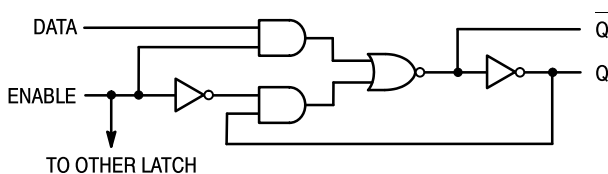

SN54/74LS375

4-BIT D LATCH LOW POWER SCHOTTKY

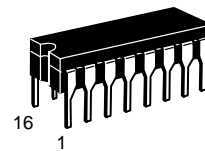

J SUFFIX
CERAMIC
CASE 620-09

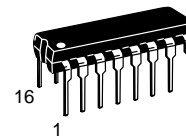

N SUFFIX
PLASTIC
CASE 648-08

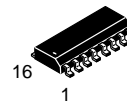

D SUFFIX
SOIC
CASE 751B-03

ORDERING INFORMATION

SN54LSXXXJ	Ceramic
SN74LSXXXN	Plastic
SN74LSXXXD	SOIC

LOGIC SYMBOL

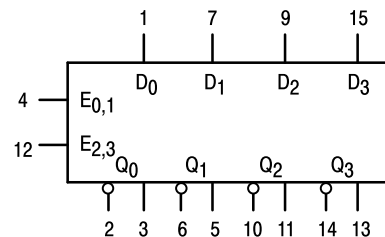

V_{CC} = PIN 16
GND = PIN 8

SN54/74LS375

DC CHARACTERISTICS OVER OPERATING TEMPERATURE RANGE (unless otherwise specified)

Symbol	Parameter		Limits			Unit	Test Conditions
			Min	Typ	Max		
V _{IH}	Input HIGH Voltage		2.0			V	Guaranteed Input HIGH Voltage for All Inputs
V _{IL}	Input LOW Voltage	54			0.7	V	Guaranteed Input LOW Voltage for All Inputs
		74			0.8		
V _{IK}	Input Clamp Diode Voltage			-0.65	-1.5	V	V _{CC} = MIN, I _{IN} = -18 mA
V _{OH}	Output HIGH Voltage	54	2.5	3.5		V	V _{CC} = MIN, I _{OH} = MAX, V _{IN} = V _{IH} or V _{IL} per Truth Table
		74	2.7	3.5		V	
V _{OL}	Output LOW Voltage	54, 74		0.25	0.4	V	I _{OL} = 4.0 mA V _{CC} = V _{CC} MIN, V _{IN} = V _{IL} or V _{IH} per Truth Table
		74		0.35	0.5	V	
I _{IH}	Input HIGH Current	D Input E Input			20 80	μA	V _{CC} = MAX, V _{IN} = 2.7 V
		D Input E Input			0.1 0.4	mA	V _{CC} = MAX, V _{IN} = 7.0 V
I _{IL}	Input LOW Current	D Input E Input			-0.4 -1.6	mA	V _{CC} = MAX, V _{IN} = 0.4 V
I _{OS}	Short Circuit Current (Note 1)		-20		-100	mA	V _{CC} = MAX
I _{CC}	Power Supply Current				12	mA	V _{CC} = MAX

Note 1: Not more than one output should be shorted at a time, nor for more than 1 second.

AC CHARACTERISTICS (T_A = 25°C, V_{CC} = 5.0 V)

Symbol	Parameter		Limits			Unit	Test Conditions
			Min	Typ	Max		
t _{PLH} t _{PHL}	Propagation Delay, Data to Q			15 9.0	27 17	ns	V _{CC} = 5.0 V C _L = 15 pF
t _{PLH} t _{PHL}	Propagation Delay, Data to \bar{Q}			12 7.0	20 15	ns	
t _{PLH} t _{PHL}	Propagation Delay, Enable to Q			15 14	27 25	ns	
t _{PLH} t _{PHL}	Propagation Delay, Enable to \bar{Q}			16 7.0	30 15	ns	

SN54/74LS375

LOGIC DIAGRAM

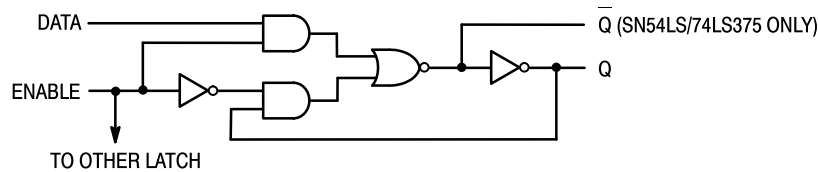

GUARANTEED OPERATING RANGES

Symbol	Parameter		Min	Typ	Max	Unit
V_{CC}	Supply Voltage	54 74	4.5 4.75	5.0 5.0	5.5 5.25	V
T_A	Operating Ambient Temperature Range	54 74	-55 0	25 25	125 70	°C
I_{OH}	Output Current — High	54, 74			-0.4	mA
I_{OL}	Output Current — Low	54 74			4.0 8.0	mA

AC SETUP REQUIREMENTS ($T_A = 25^\circ\text{C}$, $V_{CC} = 5.0\text{ V}$)

Symbol	Parameter	Limits			Unit	Test Conditions
		Min	Typ	Max		
t_W	Enable Pulse Width	20			ns	$V_{CC} = 5.0\text{ V}$
t_s	Setup Time	20			ns	
t_h	Hold Time	0			ns	

AC WAVEFORMS

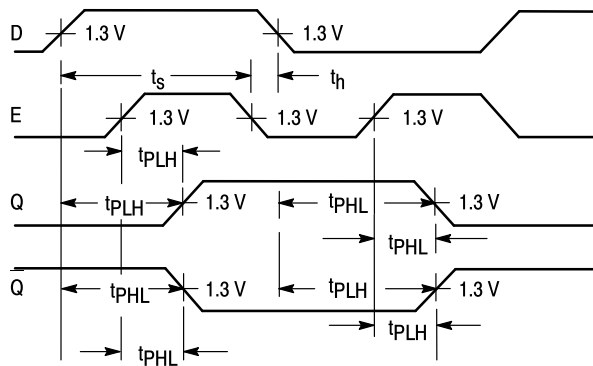

DEFINITION OF TERMS

SETUP TIME (t_s) — is defined as the minimum time required for the correct logic level to be present at the logic input prior to the clock transition from LOW-to-HIGH in order to be recognized and transferred to the outputs.

HOLD TIME (t_h) — is defined as the minimum time following

the clock transition from LOW-to-HIGH that the logic level must be maintained at the input in order to ensure continued recognition. A negative HOLD TIME indicates that the correct logic level may be released prior to the clock transition from LOW-to-HIGH and still be recognized.

**Case 751B-03 D Suffix
16-Pin Plastic
SO-16**



- NOTES:
1. DIMENSIONING AND TOLERANCING PER ANSI Y14.5M, 1982.
 2. CONTROLLING DIMENSION: MILLIMETER.
 3. DIMENSION A AND B DO NOT INCLUDE MOLD PROTRUSION.
 4. MAXIMUM MOLD PROTRUSION 0.15 (0.006) PER SIDE.
 5. 751B-01 IS OBSOLETE, NEW STANDARD 751B-03.

DIM	MILLIMETERS		INCHES	
	MIN	MAX	MIN	MAX
A	9.80	10.00	0.386	0.393
B	3.80	4.00	0.150	0.157
C	1.35	1.75	0.054	0.068
D	0.35	0.49	0.014	0.019
F	0.40	1.25	0.016	0.049
G	1.27 BSC		0.050 BSC	
J	0.19	0.25	0.008	0.009
K	0.10	0.25	0.004	0.009
M	0°	7°	0°	7°
P	5.80	6.20	0.229	0.244
R	0.25	0.50	0.010	0.019

**Case 648-08 N Suffix
16-Pin Plastic**



- NOTES:
1. DIMENSIONING AND TOLERANCING PER ANSI Y14.5M, 1982.
 2. CONTROLLING DIMENSION: INCH.
 3. DIMENSION "L" TO CENTER OF LEADS WHEN FORMED PARALLEL.
 4. DIMENSION "B" DOES NOT INCLUDE MOLD FLASH.
 5. ROUNDED CORNERS OPTIONAL.
 6. 648-01 THRU -07 OBSOLETE, NEW STANDARD 648-08.

DIM	MILLIMETERS		INCHES	
	MIN	MAX	MIN	MAX
A	18.80	19.55	0.740	0.770
B	6.35	6.85	0.250	0.270
C	3.69	4.44	0.145	0.175
D	0.39	0.53	0.015	0.021
F	1.02	1.77	0.040	0.070
G	2.54 BSC		0.100 BSC	
H	1.27 BSC		0.050 BSC	
J	0.21	0.38	0.008	0.015
K	2.80	3.30	0.110	0.130
L	7.50	7.74	0.295	0.305
M	0°	10°	0°	10°
S	0.51	1.01	0.020	0.040

**Case 620-09 J Suffix
16-Pin Ceramic Dual In-Line**

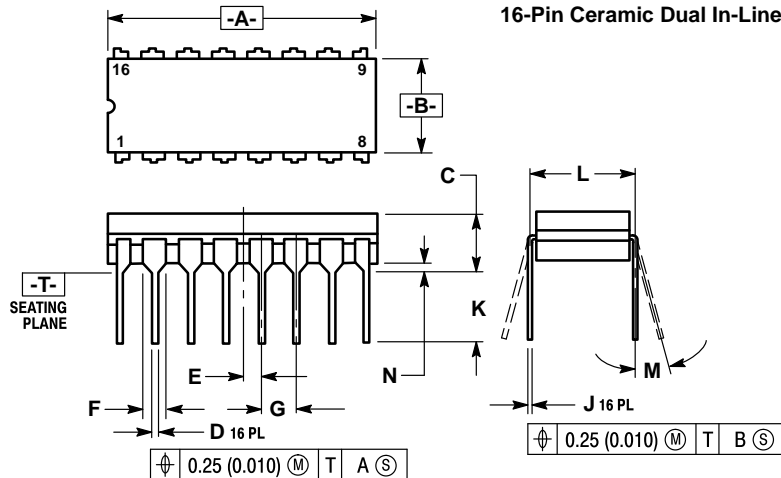

- NOTES:
1. DIMENSIONING AND TOLERANCING PER ANSI Y14.5M, 1982.
 2. CONTROLLING DIMENSION: INCH.
 3. DIMENSION L TO CENTER OF LEAD WHEN FORMED PARALLEL.
 4. DIM F MAY NARROW TO 0.76 (0.030) WHERE THE LEAD ENTERS THE CERAMIC BODY.
 5. 620-01 THRU -08 OBSOLETE, NEW STANDARD 620-09.

DIM	MILLIMETERS		INCHES	
	MIN	MAX	MIN	MAX
A	19.05	19.55	0.750	0.770
B	6.10	7.36	0.240	0.290
C	—	4.19	—	0.165
D	0.39	0.53	0.015	0.021
E	1.27 BSC		0.050 BSC	
F	1.40	1.77	0.055	0.070
G	2.54 BSC		0.100 BSC	
J	0.23	0.27	0.009	0.011
K	—	5.08	—	0.200
L	7.62 BSC		0.300 BSC	
M	0°	15°	0°	15°
N	0.39	0.88	0.015	0.035

Motorola reserves the right to make changes without further notice to any products herein. Motorola makes no warranty, representation or guarantee regarding the suitability of its products for any particular purpose, nor does Motorola assume any liability arising out of the application or use of any product or circuit, and specifically disclaims any and all liability, including without limitation consequential or incidental damages. "Typical" parameters can and do vary in different applications. All operating parameters, including "Typicals" must be validated for each customer application by customer's technical experts. Motorola does not convey any license under its patent rights nor the rights of others. Motorola products are not designed, intended, or authorized for use as components in systems intended for surgical implant into the body, or other applications intended to support or sustain life, or for any other application in which the failure of the Motorola product could create a situation where personal injury or death may occur. Should Buyer purchase or use Motorola products for any such unintended or unauthorized application, Buyer shall indemnify and hold Motorola and its officers, employees, subsidiaries, affiliates, and distributors harmless against all claims, costs, damages, and expenses, and reasonable attorney fees arising out of, directly or indirectly, any claim of personal injury or death associated with such unintended or unauthorized use, even if such claim alleges that Motorola was negligent regarding the design or manufacture of the part. Motorola and  are registered trademarks of Motorola, Inc. Motorola, Inc. is an Equal Opportunity/Affirmative Action Employer.

Literature Distribution Centers:

USA: Motorola Literature Distribution; P.O. Box 20912; Phoenix, Arizona 85036.

EUROPE: Motorola Ltd.; European Literature Centre; 88 Tanners Drive, Blakelands, Milton Keynes, MK14 5BP, England.

JAPAN: Nippon Motorola Ltd.; 4-32-1, Nishi-Gotanda, Shinagawa-ku, Tokyo 141, Japan.

ASIA PACIFIC: Motorola Semiconductors H.K. Ltd.; Silicon Harbour Center, No. 2 Dai King Street, Tai Po Industrial Estate, Tai Po, N.T., Hong Kong.



This datasheet has been download from:

www.datasheetcatalog.com

Datasheets for electronics components.