

HD74LS122 ● Retriggerable Monostable Multivibrators (with Clear)

This d-c triggered multivibrator features output pulse width control by three methods. The basic pulse time is programmed by selection of external resistance and capacitance values. The HD74LS122 has an internal timing resistor that allows the circuit to be used with only an external capacitor, if so desired. Once triggered, the basic pulse width may be extended by retriggering the gated low-level-active (A) or high-level-active (B) inputs or be reduced by use of the overriding clear. Fig. 1 illustrates pulse control by retriggering and early clear. This device is provided with enough Schmitt hysteresis to ensure jitter-free triggering from the B input with transition rates as slow as 0.1 mV/ns.

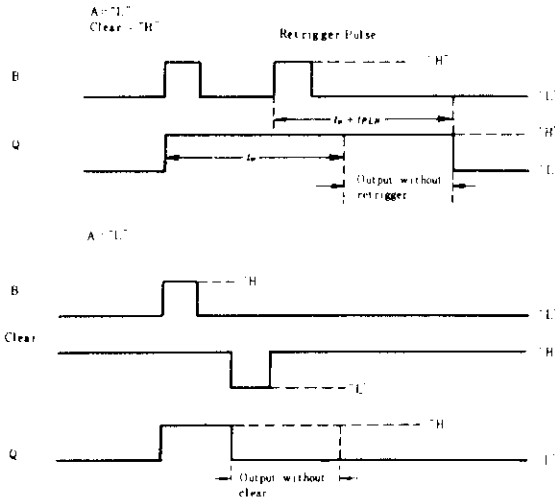
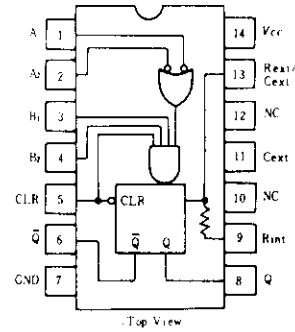

Fig.1 Typical Input/Output Pulses

RECOMMENDED OPERATING CONDITIONS

Item	Symbol	min	typ	max	Unit
Input pulse width	t_w	40	—	—	ns
External timing resistance	R_{ext}	5	—	260	k Ω
External capacitance	C_{ext}	Non restriction			
Wiring capacitance at R_{ext}/C_{ext} terminal	R_{ext}/C_{ext}	—	—	50	pF

PIN ARRANGEMENT



BLOCK DIAGRAM

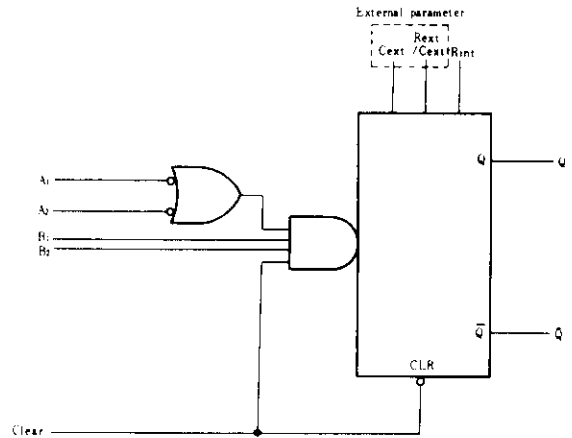

FUNCTION TABLE

Clear	Inputs					Outputs	
	A ₁	A ₂	B ₁	B ₂	Q	Q̄	
L	X	X	X	X	L	H	
X	H	H	X	X	L	H	
X	X	X	L	X	L	H	
X	X	X	X	L	L	H	
H	L	X	↑	H	⌋	⌋	
H	L	X	H	↑	⌋	⌋	
H	X	L	↑	H	⌋	⌋	
H	X	L	H	↑	⌋	⌋	
H	H	↓	H	H	⌋	⌋	
H	↓	H	H	H	⌋	⌋	
H	↓	H	H	H	⌋	⌋	
↑	L	X	H	H	⌋	⌋	
↑	X	L	H	H	⌋	⌋	

H: high level, L: low level, X: irrelevant.
 ↑: transition from low to high level.
 ↓: transition from high to low level.
 ⌋: one high-level pulse.
 ⌋: one low-level pulse.

■ ELECTRICAL CHARACTERISTICS ($T_a = -20 \sim +75^\circ\text{C}$)

Item	Symbol	Test Conditions	min	typ*	max	Unit
Input voltage	V_{IH}		2.0	—	—	V
	V_{IL}		—	—	0.8	V
Output voltage	V_{OH}	$V_{CC}=4.75\text{V}, V_{IH}=2\text{V}, V_{IL}=0.8\text{V}, I_{OH}=-400\mu\text{A}$	2.7	—	—	V
	V_{OL}	$V_{CC}=4.75\text{V}, V_{IH}=2\text{V}$	—	—	0.4	V
		$V_{IL}=0.8\text{V}$	$I_{OL}=4\text{mA}$	—	—	
Input current	I_{IH}	$V_{CC}=5.25\text{V}, V_I=2.7\text{V}$	—	—	20	μA
	I_{IL}	$V_{CC}=5.25\text{V}, V_I=0.4\text{V}$	—	—	-0.4	mA
	I_I	$V_{CC}=5.25\text{V}, V_I=7\text{V}$	—	—	0.1	mA
Short-circuit output current	I_{OS}	$V_{CC}=5.25\text{V}$	-20	—	-100	mA
Supply current **	I_{CC}	$V_{CC}=5.25\text{V}$	—	6	11	mA
Input clamp voltage	V_{IK}	$V_{CC}=4.75\text{V}, I_{IN}=-18\text{mA}$	—	—	-1.5	V

* $V_{CC} = 5\text{V}, T_a = 25^\circ\text{C}$

** With all outputs open and 4.5V applied to all data and clear inputs, I_{CC} is measured after a momentary ground, then 4.5V, is applied to clock.

Note) To measure V_{OH} at Q, V_{OL} at \bar{Q} , or I_{OS} at Q, ground R_{ext}/C_{ext} , apply 2V to B and clear, and pulse A from 2V to 0V.

■ SWITCHING CHARACTERISTICS ($V_{CC} = 5\text{V}, T_a = 25^\circ\text{C}$)

Item	Symbol	Inputs	Outputs	Test Conditions	min	typ	max	Unit
Propagation delay time	t_{PLH}	A	Q	$C_{ext}=0$ $R_{ext}=5\text{k}\Omega$ $C_L=15\text{pF}$ $R_L=2\text{k}\Omega$	—	23	33	ns
	t_{PHL}		\bar{Q}		—	32	45	
	t_{PLH}	B	Q		—	23	44	
	t_{PHL}		\bar{Q}		—	34	56	
	t_{PLH}	Clear	Q		—	20	27	
	t_{PHL}		\bar{Q}		—	28	45	
Output pulse width	$t_{out(max)}$	A or B	Q	$C_{ext}=1000\text{pF}, R_{ext}=10\text{k}\Omega$ $C_L=15\text{pF}, R_L=2\text{k}\Omega$	—	116	200	μs
	t_{out}	A or B	Q		4	4.5	5	

■ TYPICAL APPLICATION DATA FOR HD74LS122

For pulse widths when $C_{ext} \leq 1000\text{pF}$, See Fig. 3.

The output pulse is primarily a function of the external capacitor and resistor. For $C_{ext} > 1000\text{pF}$, the output pulse width (t_w) is defined as: $t_w(\text{out}) = K \cdot R_{ext} \cdot C_{ext}$; See Fig. 4

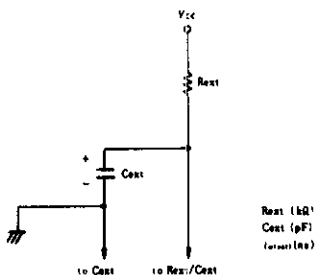

Fig.2 Timing Component Connections

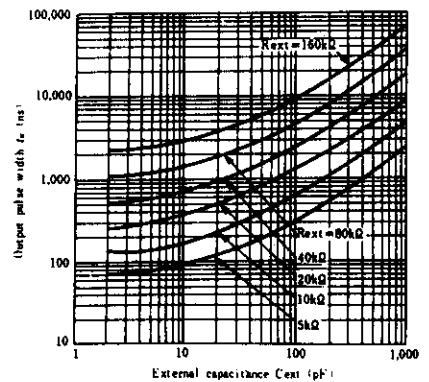
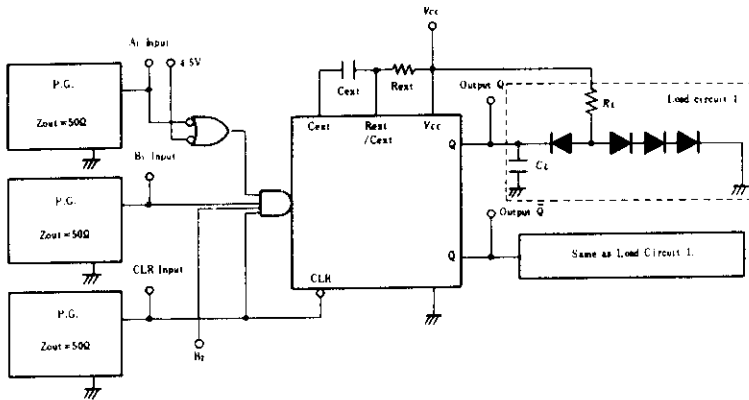

Fig.3 Typical Output Pulse Width ($C_{ext} \leq 1000\text{pF}$)

TESTING METHOD

1) Test Circuit



- Notes)
1. C_L includes probe and jig capacitance.
 2. All diodes are 1S2074 \oplus .
 3. Input pulse; $t_{TLH} \leq 15\text{ns}$, $t_{THL} \leq 6\text{ns}$.

Waveform

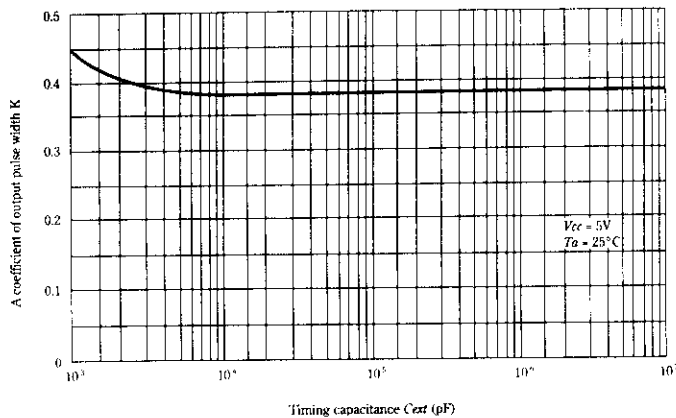
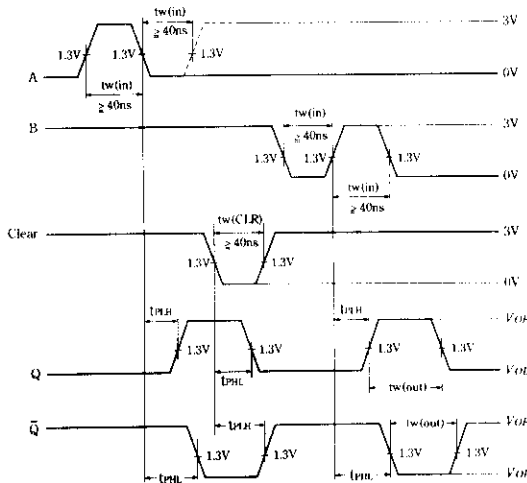

Fig.4 C_{est} vs K ($C_{est} > 1000\text{pF}$)



Hitachi Code	DP-14
JEDEC	Conforms
EIAJ	Conforms
Weight (reference value)	0.97 g



Hitachi Code	FP-14DA
JEDEC	—
EIAJ	Conforms
Weight (reference value)	0.23 g

*Dimension including the plating thickness
Base material dimension



Hitachi Code	FP-14DN
JEDEC	Conforms
EIAJ	Conforms
Weight (reference value)	0.13 g

Cautions

1. Hitachi neither warrants nor grants licenses of any rights of Hitachi's or any third party's patent, copyright, trademark, or other intellectual property rights for information contained in this document. Hitachi bears no responsibility for problems that may arise with third party's rights, including intellectual property rights, in connection with use of the information contained in this document.
2. Products and product specifications may be subject to change without notice. Confirm that you have received the latest product standards or specifications before final design, purchase or use.
3. Hitachi makes every attempt to ensure that its products are of high quality and reliability. However, contact Hitachi's sales office before using the product in an application that demands especially high quality and reliability or where its failure or malfunction may directly threaten human life or cause risk of bodily injury, such as aerospace, aeronautics, nuclear power, combustion control, transportation, traffic, safety equipment or medical equipment for life support.
4. Design your application so that the product is used within the ranges guaranteed by Hitachi particularly for maximum rating, operating supply voltage range, heat radiation characteristics, installation conditions and other characteristics. Hitachi bears no responsibility for failure or damage when used beyond the guaranteed ranges. Even within the guaranteed ranges, consider normally foreseeable failure rates or failure modes in semiconductor devices and employ systemic measures such as fail-safes, so that the equipment incorporating Hitachi product does not cause bodily injury, fire or other consequential damage due to operation of the Hitachi product.
5. This product is not designed to be radiation resistant.
6. No one is permitted to reproduce or duplicate, in any form, the whole or part of this document without written approval from Hitachi.
7. Contact Hitachi's sales office for any questions regarding this document or Hitachi semiconductor products.

HITACHI

Hitachi, Ltd.

Semiconductor & Integrated Circuits.
Nippon Bldg., 2-6-2, Ohte-machi, Chiyoda-ku, Tokyo 100-0004, Japan
Tel: Tokyo (03) 3270-2111 Fax: (03) 3270-5109

URL North America : <http://semiconductor.hitachi.com/>
 Europe : <http://www.hitachi-eu.com/hel/ecg>
 Asia (Singapore) : <http://www.has.hitachi.com.sg/grp3/sicd/index.htm>
 Asia (Taiwan) : http://www.hitachi.com.tw/E/Product/SICD_Frame.htm
 Asia (HongKong) : <http://www.hitachi.com.hk/eng/bo/grp3/index.htm>
 Japan : <http://www.hitachi.co.jp/Sicd/indx.htm>

For further information write to:

Hitachi Semiconductor
(America) Inc.
179 East Tasman Drive,
San Jose, CA 95134
Tel: <1> (408) 433-1990
Fax: <1> (408) 433-0223

Hitachi Europe GmbH
Electronic components Group
Dornacher Straße 3
D-85622 Feldkirchen, Munich
Germany
Tel: <49> (89) 9 9180-0
Fax: <49> (89) 9 29 30 00

Hitachi Europe Ltd.
Electronic Components Group.
Whitebrook Park
Lower Cookham Road
Maidenhead
Berkshire SL6 8YA, United Kingdom
Tel: <44> (1628) 585000
Fax: <44> (1628) 778322

Hitachi Asia Pte. Ltd.
16 Collyer Quay #20-00
Hitachi Tower
Singapore 049318
Tel: 535-2100
Fax: 535-1533

Hitachi Asia Ltd.
Taipei Branch Office
3F, Hung Kuo Building, No.167,
Tun-Hwa North Road, Taipei (105)
Tel: <886> (2) 2718-3666
Fax: <886> (2) 2718-8180

Hitachi Asia (Hong Kong) Ltd.
Group III (Electronic Components)
7/F., North Tower, World Finance Centre,
Harbour City, Canton Road, Tsim Sha Tsui,
Kowloon, Hong Kong
Tel: <852> (2) 735 9218
Fax: <852> (2) 730 0281
Telex: 40815 HITEC HX

Copyright ' Hitachi, Ltd., 1999. All rights reserved. Printed in Japan.

HITACHI

This datasheet has been downloaded from:

www.DatasheetCatalog.com

Datasheets for electronic components.