

## Application Customized Examples

### Remote Maintenance (Stryker)

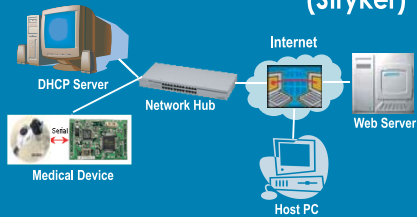

#### Objective

1. To transmit usage and log data of medical device into web server
2. To support remote diagnosis

#### Feature

1. Serial Command Interface
2. DHCP client
3. Auto Remote Downloading Function of Medical Device Firmware

### Entrance Control System (Synel)

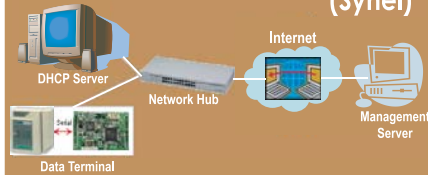

#### Objective

1. To transmit usage data related with Entrance control into Server
2. To support the entrance control system

#### Feature

1. Automatic Configuration by Option Field of DHCP server
2. DHCP client
3. Supporting two modes with Debug & Operating

### Controller for Entrance Control System (Tyco Korea)

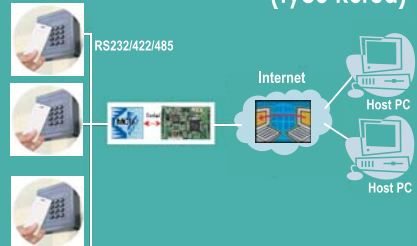

#### Objective

1. To gather usage data of each terminal equipment and transmit them to central server
2. To transmit control data from central server to each terminal equipment

#### Feature

1. Serial command interface
2. To apply customized data protocol defined by user

### Auto Sensing System using RF-ID/RF Signal (Hunter, LG-IS)

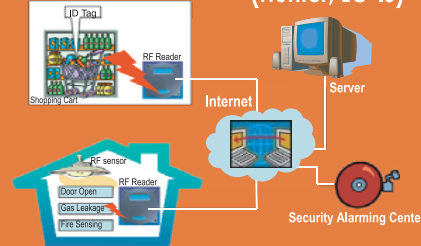

#### Objective

1. Terminal for gathering information using RF interface
2. Automatic distribution system, Building Security system etc.

#### Feature

1. Serial command interface
2. Customized data protocol defined by user
3. Automatic remote downloading function of device's firmware

## EMBEDDED GATEWAY

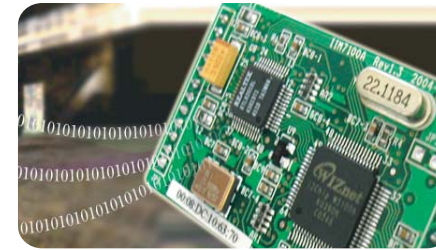

EG(Embedded Gateway)'s essential competitiveness comes from WIZnet hardwired TCP/IP Technology.

EG-SR-7100A is a Serial to Ethernet Con-version Module, has been adopting worldwide.



### EG-SR-7100A Overview



### High Performance & Reliability

- Up to 230 Kbps for Serial transmission speed
- Implemented by Hardwired TCP/IP Chip, not software stack
- Network Virus Protection for your system

### Cost effectiveness & technical support directly

- Ready-made & optimized module for your resource saving
- A plenty of technical materials for the reference
- Fully technical supporting from engineer in the shop

### Easy Interface & Powerful Functionality

- Configuration tool program : firmware updating, setting all serial parameters, selectable transmission condition
- Functional testing program : Serial and Ethernet

### Source Open Policy for customization

- Support all program sources with commercial version
- Customizable at any case

# EG-SR-7100A

## Embedded Ethernet Gateway for Devices with Serial Interface

- Plug & Play Serial-to-Ethernet module
- High stability & reliability by Hardwired TCP/IP Chip
- Simply Customizable with Firmware source code
- 10/100Mbps Ethernet interface, Max. 230Kbps Serial interface
- Compact 50mm X 30mm size
- Configuration Program : Easy Interface and Powerful Functionality
- Source Open Policy for the Best implementation and the Shortest Developing Term : Firmware, Configuration tool program, Functional testing program for Serial & Ethernet



### EG-SR-7100A Block Diagram

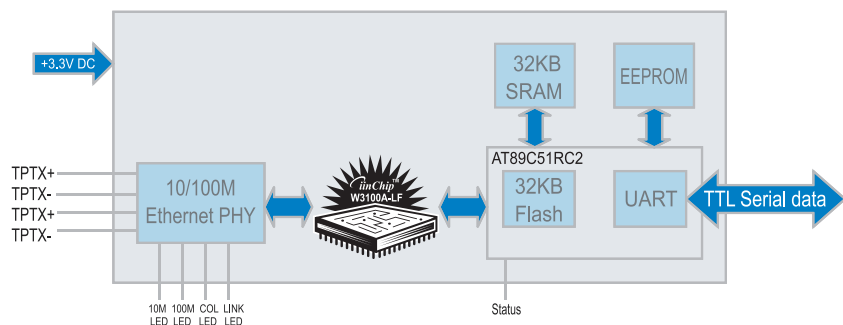

### Specifications

Category	Specification
Ethernet	10/100M auto detection
CPU	AT89C51RC2(32KB Flash)
Serial	RS-232 LVTTTL
Flow control	None, XON/XOFF, RTS/CTS
Serial format	8-N-1, 8-O-1, 8-E-1, 7-O-1, 7-E-1 (Data-Parity-Stop bit)
Speed	1200bps to 230Kbps
Protocol	TCP, UDP, IP, ICMP, ARP, DHCP
Operating Modes	TCP Server, TCP Client, UDP
Utility	Configuration utility
Management	Serial console, Window utility
Power	3.3V, 150mA
Dimensions	50 x 30 x 8.85mm
Connector type	2x12 2mm Pin header array
Temperature	-10°C ~70°C (Operating), -40°C~85°C (Storage)
Humidity	10-90%

### Evaluation Board

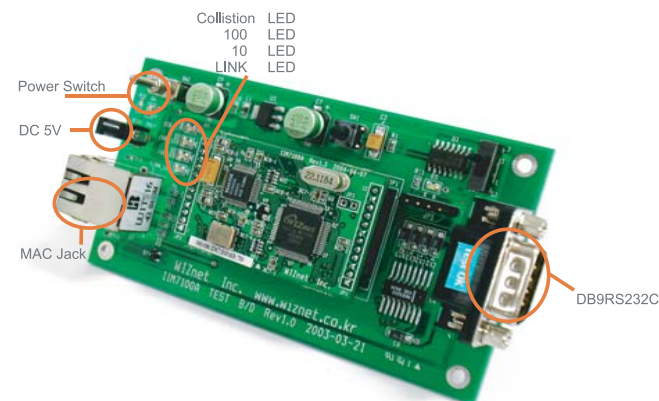

### Contents

- EG-SR-7100A
- Module and Evaluation Board
- Firmware Source & H/W Schematic of Evaluation Board
- Configuration Program & Source for Windows
- Power Supply, UTP Cable & Serial Cable
- User's manual



### Ordering Information

- **EG-SR-7100A** : Serial-to-Ethernet Module
- **EG-SR-7100A-EVB** : Evaluation Board for EG-SR-7100A

