

CNY17-1X, CNY17-2X, CNY17-3X, CNY17-4X, CNY17-5X  
 CNY17-1, CNY17-2, CNY17-3, CNY17-4, CNY17-5



**OPTICALLY COUPLED  
 ISOLATOR  
 PHOTOTRANSISTOR OUTPUT**

**APPROVALS**

- UL recognised, File No. E91231
- 'X' SPECIFICATION APPROVALS**
- VDE0884 in 3 available lead forms :-
  - STD
  - G form
  - SMD approved to CECC 00802
- Certified to EN60950 by the following Test Bodies :-
  - Nemko - Certificate No. P01102464
  - Fimko - Certificate No. FI18166
  - Semko - Reference No. 0202037/01-22
  - Demko - Certificate No. 311158-01
- BSI approved - Certificate No. 8001

**DESCRIPTION**

The CNY17-1, CNY17-2, CNY17-3, CNY17-4, CNY17-5 series of optically coupled isolators consist of an infrared light emitting diode and a NPN silicon photo transistor in a standard 6 pin dual in line plastic package.

**FEATURES**

- Options :-
  - 10mm lead spread - add G after part no.
  - Surface mount - add SM after part no.
  - Tape&reel - add SMT&R after part no.
- High  $BV_{CEO}$  (70V min)
- High Isolation Voltage (5.3kV<sub>RMS</sub>, 7.5kV<sub>PK</sub>)
- All electrical parameters 100% tested
- Custom electrical selections available

**APPLICATIONS**

- DC motor controllers
- Industrial systems controllers
- Measuring instruments
- Signal transmission between systems of different potentials and impedances

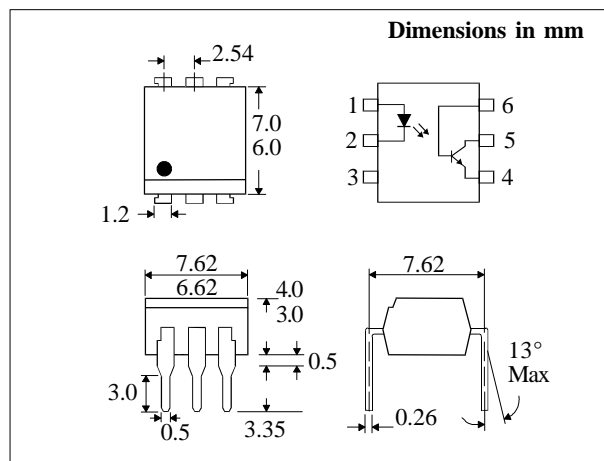
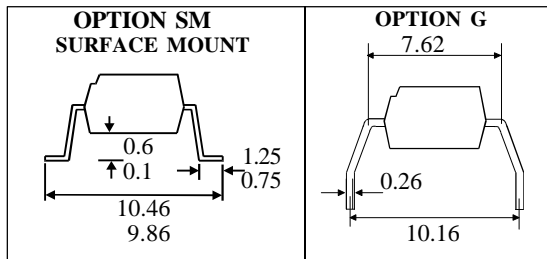

**ABSOLUTE MAXIMUM RATINGS  
 (25°C unless otherwise specified)**

Storage Temperature	-55°C to + 150°C
Operating Temperature	-55°C to + 100°C
Lead Soldering Temperature (1/16 inch (1.6mm) from case for 10 secs)	260°C

**INPUT DIODE**

Forward Current	60mA
Reverse Voltage	6V
Power Dissipation	105mW

**OUTPUT TRANSISTOR**

Collector-emitter Voltage $BV_{CEO}$	70V
Collector-base Voltage $BV_{CBO}$	70V
Emitter-collector Voltage $BV_{ECO}$	6V
Power Dissipation	160mW

**POWER DISSIPATION**

Total Power Dissipation	200mW
(derate linearly 2.67mW/°C above 25°C)	

**ISOCOM COMPONENTS LTD**  
 Unit 25B, Park View Road West,  
 Park View Industrial Estate, Brenda Road  
 Hartlepool, TS25 1YD England Tel: (01429)863609  
 Fax: (01429) 863581 e-mail sales@isocom.co.uk  
 http://www.isocom.com

**ISOCOM INC**  
 1024 S. Greenville Ave, Suite 240,  
 Allen, TX 75002 USA  
 Tel: (214)495-0755 Fax: (214)495-0901  
 e-mail info@isocom.com  
 http://www.isocom.com

**ELECTRICAL CHARACTERISTICS (  $T_A = 25^\circ\text{C}$  Unless otherwise noted )**

PARAMETER		MIN	TYP	MAX	UNITS	TEST CONDITION
Input	Forward Voltage ( $V_F$ )		1.2	1.65	V	$I_F = 60\text{mA}$
	Reverse Current ( $I_R$ )			10	$\mu\text{A}$	$V_R = 6\text{V}$
Output	Collector-emitter Breakdown ( $BV_{CEO}$ )	70			V	$I_C = 1\text{mA}$ ( Note 2 )
	Collector-base Breakdown ( $BV_{CBO}$ )	70			V	$I_C = 100\mu\text{A}$
	Emitter-collector Breakdown ( $BV_{ECO}$ )	6			V	$I_E = 100\mu\text{A}$
	Collector-emitter Dark Current ( $I_{CEO}$ )			50	nA	$V_{CE} = 10\text{V}$
Coupled	Current Transfer Ratio (CTR) (Note 2)					
	CNY17-1	40	80		%	$10\text{mA } I_F, 5\text{V } V_{CE}$
	CNY17-2	63	125		%	$10\text{mA } I_F, 5\text{V } V_{CE}$
	CNY17-3	100	200		%	$10\text{mA } I_F, 5\text{V } V_{CE}$
	CNY17-4	160	320		%	$10\text{mA } I_F, 5\text{V } V_{CE}$
	CNY17-5	200	400		%	$10\text{mA } I_F, 5\text{V } V_{CE}$
	CNY17-1	13			%	$1\text{mA } I_F, 5\text{V } V_{CE}$
	CNY17-2	22			%	$1\text{mA } I_F, 5\text{V } V_{CE}$
	CNY17-3	34			%	$1\text{mA } I_F, 5\text{V } V_{CE}$
	CNY17-4	56			%	$1\text{mA } I_F, 5\text{V } V_{CE}$
	CNY17-5	68			%	$1\text{mA } I_F, 5\text{V } V_{CE}$
	Collector-emitter Saturation Voltage $V_{CE(SAT)}$			0.4	V	$10\text{mA } I_F, 2.5\text{mA}$
	Input to Output Isolation Voltage $V_{ISO}$	5300			$V_{RMS}$	See note 1
Input-output Isolation Resistance $R_{ISO}$	$5 \times 10^{10}$			$\Omega$	$V_{IO} = 500\text{V}$ (note 1)	

Note 1 Measured with input leads shorted together and output leads shorted together.

Note 2 Special Selections are available on request. Please consult the factory.

**TYPICAL SWITCHING CHARACTERISTICS**

1. Linear Operation ( without saturation ) Fig 1.  
 $I_F = 10\text{mA}, V_{CC} = 5\text{V}, R_L = 75\Omega$

			UNITS
Turn-on Time	$t_{on}$	3.0	$\mu\text{s}$
Rise Time	$t_r$	2.0	$\mu\text{s}$
Turn-off Time	$t_{off}$	2.3	$\mu\text{s}$
Fall Time	$t_f$	2.0	$\mu\text{s}$
Cut-off Frequency	$F_{CO}$	250	kHz

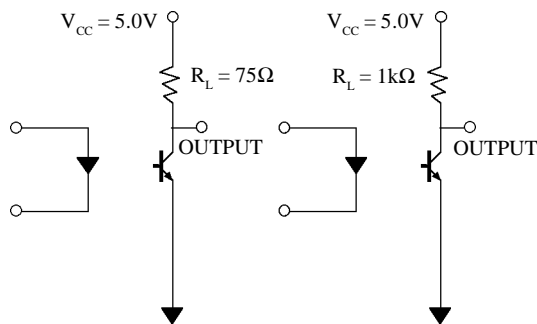
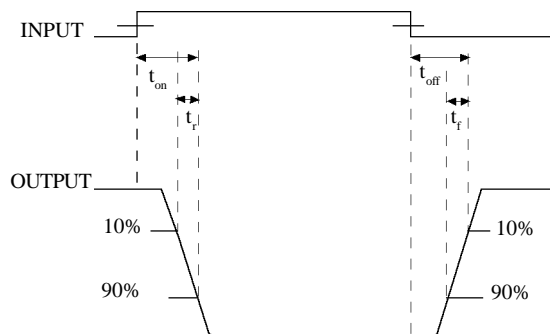

FIG 1

FIG 2

2. Switching Operation ( with saturation ) Fig 2  
 $V_{CC} = 5\text{V}, R_L = 1\text{k}\Omega$

GROUP	-1 ( $I_F = 20\text{mA}$ )	-2 and -3 ( $I_F = 10\text{mA}$ )	-4 ( $I_F = 5\text{mA}$ )	UNITS	
Turn-on Time	$t_{on}$	3.0	4.2	6.0	$\mu\text{s}$
Rise Time	$t_r$	2.0	3.0	4.6	$\mu\text{s}$
Turn-off Time	$t_{off}$	18	23	25	$\mu\text{s}$
Fall Time	$t_f$	11	14	15	$\mu\text{s}$
$V_{CESAT}$				$\leq 0.4$	V



**Collector Power Dissipation vs. Ambient Temperature**

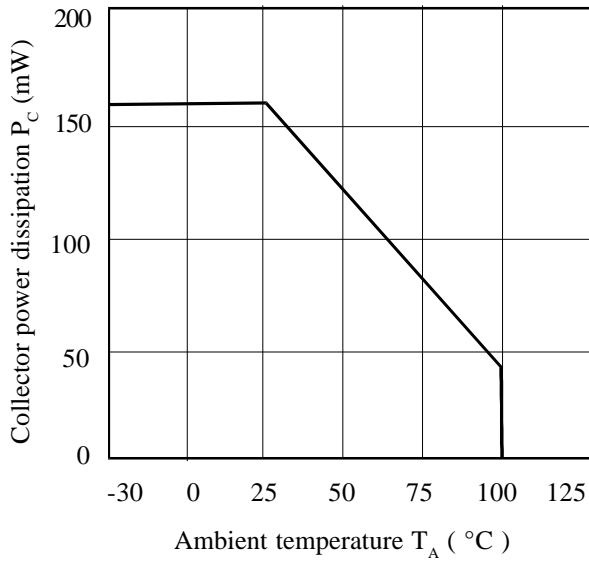

**Collector Current vs. Collector-emitter Voltage (normalised to CNY17-3)**

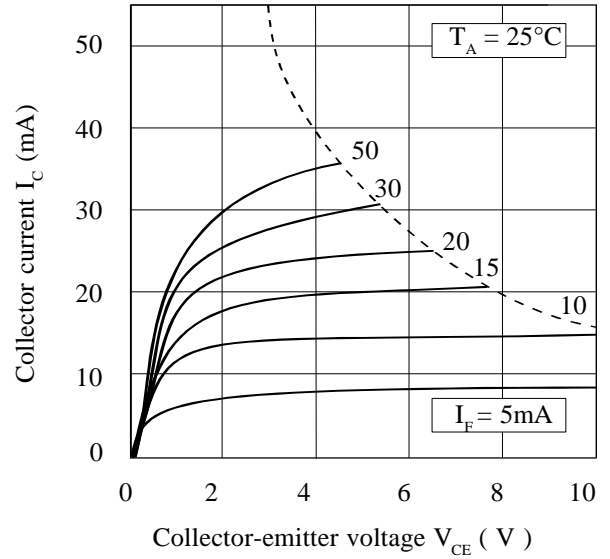

**Forward Current vs. Ambient Temperature**

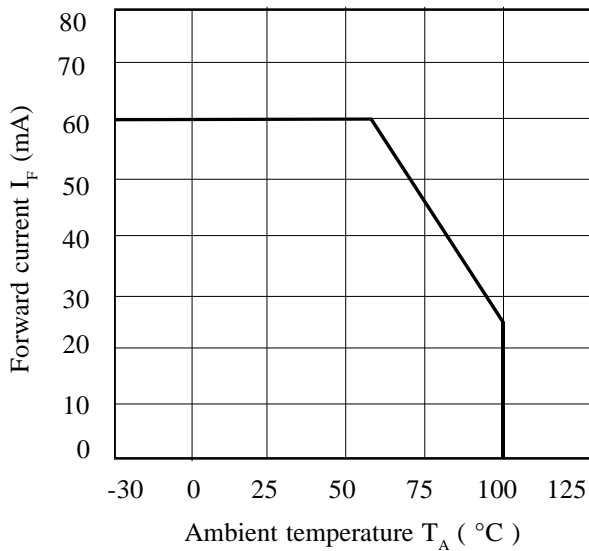

**Current Transfer Ratio vs. Forward Current**

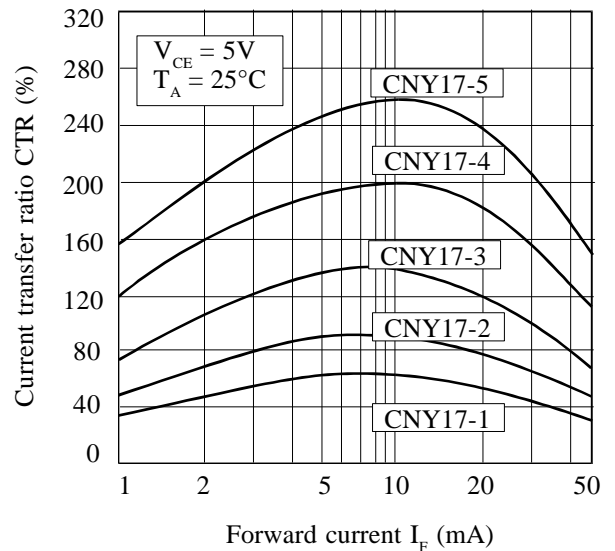

**Relative Current Transfer Ratio vs. Ambient Temperature**



**Collector-emitter Saturation Voltage vs. Ambient Temperature**



This datasheet has been downloaded from:

[www.DatasheetCatalog.com](http://www.DatasheetCatalog.com)

Datasheets for electronic components.