

FEATURES

DC PERFORMANCE

- 25 μV max Offset Voltage (AD705T)
- 0.6 $\mu\text{V}/^\circ\text{C}$ max Drift (AD705K/T)
- 100 pA max Input Bias Current (AD705K)
- 600 pA max I_B Over MIL Temperature Range (AD705T)
- 114 dB min CMRR (AD705K/T)
- 114 dB min PSRR (AD705T)
- 200 V/mV min Open Loop Gain
- 0.5 μV p-p typ Noise, 0.1 Hz to 10 Hz
- 600 μA max Supply Current

AC PERFORMANCE

- 0.15 V/ μs Slew Rate
- 800 kHz Unity Gain Crossover Frequency
- 10,000 pF Capacitive Load Drive Capability

Low Cost

- Available in 8-Pin Plastic Mini-DIP, Hermetic Cerdip and Surface Mount (SOIC) Packages
- MIL-STD-883B Processing Available
- Dual Version Available: AD706
- Quad Version: AD704

APPLICATIONS

- Low Frequency Active Filters
- Precision Instrumentation
- Precision Integrators

PRODUCT DESCRIPTION

The AD705 is a low power bipolar op amp that has the low input bias current of a BiFET amplifier but which offers a significantly lower I_B drift over temperature. The AD705 offers many of the advantages of BiFET and bipolar op amps without their inherent disadvantages. It utilizes superbeta bipolar input transistors to achieve the picoampere input bias current levels of FET input amplifiers (at room temperature), while its I_B typically only increases 5 times vs. BiFET amplifiers which exhibit a 1000X increase over temperature. This means that, at room temperature, while a typical BiFET may have less I_B than the AD705, the BiFET's input current will increase to a level of several nA at +125°C. Superbeta bipolar technology also permits the AD705 to achieve the microvolt offset voltage and low noise characteristics of a precision bipolar input amplifier.

The AD705 is a high quality replacement for the industry-standard OP07 amplifier while drawing only one sixth of its power supply current. Since it has only 1/20th the input bias current of an OP07, the AD705 can be used with much higher source impedances, while providing the same level of dc precision. In addition, since the input bias currents are at picoAmp

REV. B

Information furnished by Analog Devices is believed to be accurate and reliable. However, no responsibility is assumed by Analog Devices for its use, nor for any infringements of patents or other rights of third parties which may result from its use. No license is granted by implication or otherwise under any patent or patent rights of Analog Devices.

CONNECTION DIAGRAM

Plastic Mini-DIP (N)
Cerdip (Q) and
Plastic SOIC (R) Packages

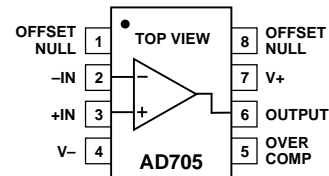

levels, the commonly used “balancing” resistor (connected between the noninverting input of a bipolar op amp and ground) is not required.

The AD705 is an excellent choice for use in low frequency active filters in 12- and 14-bit data acquisition systems, in precision instrumentation and as a high quality integrator.

The AD705 is internally compensated for unity gain and is available in five performance grades. The AD705J and AD705K are rated over the commercial temperature range of 0°C to +70°C. The AD705A and AD705B are rated over the industrial temperature range of -40°C to +85°C. The AD705T is rated over the military temperature range of -55°C to +125°C and is available processed to MIL-STD-883B, Rev. C.

The AD705 is offered in three varieties of 8-pin package: plastic DIP, hermetic cerdip and surface mount (SOIC). “J” grade chips are also available.

PRODUCT HIGHLIGHTS

1. The AD705 is a low drift op amp that offers BiFET level input bias currents, yet has the low I_B drift of a bipolar amplifier. It upgrades the performance of circuits using op amps such as the LT1012.
2. The combination of Analog Devices’ advanced superbeta processing technology and factory trimming provides both low drift and high dc precision.
3. The AD705 can be used in applications where a chopper amplifier would normally be required but without the chopper’s inherent noise and other problems.

AD705—SPECIFICATIONS (@ $T_A = +25^\circ\text{C}$, $V_{CM} = 0\text{ V}$, and $V_S = \pm 15\text{ V}$ dc, unless otherwise noted)

Parameter	Conditions	AD705J/A			AD705K/B			AD705T			Units
		Min	Typ	Max	Min	Typ	Max	Min	Typ	Max	
INPUT OFFSET VOLTAGE											
Initial Offset			30	90		10	35		10	25	μV
Offset	T_{MIN} to T_{MAX}		45	150		25	60		25	60	μV
vs. Temp, Average TC			0.2	1.2		0.2	0.6		0.2	0.6	$\mu\text{V}/^\circ\text{C}$
vs. Supply (PSRR)	$V_S = \pm 2\text{ V}$ to $\pm 18\text{ V}$	110	129		110	129		114	129		dB
T_{MIN} to T_{MAX}	$V_S = \pm 2.5\text{ V}$ to $\pm 18\text{ V}$	108	126		108	126		108	126		dB
Long Term Stability			0.3			0.3			0.3		$\mu\text{V}/\text{month}$
INPUT BIAS CURRENT ¹											
	$V_{CM} = 0\text{ V}$		60	150		30	100		30	100	pA
	$V_{CM} = \pm 13.5\text{ V}$		80	200		50	150		50	150	pA
vs. Temp, Average TC			0.3			0.3			0.6		$\text{pA}/^\circ\text{C}$
T_{MIN} to T_{MAX}	$V_{CM} = 0\text{ V}$		80	250		50	150		90	600	pA
T_{MIN} to T_{MAX}	$V_{CM} = \pm 13.5\text{ V}$		100	450		70	350		120	750	pA
INPUT OFFSET CURRENT											
	$V_{CM} = 0\text{ V}$		40	150		30	100		30	100	pA
	$V_{CM} = \pm 13.5\text{ V}$		40	200		30	150		30	150	pA
vs. Temp, Average TC			0.3			0.3			0.4		$\text{pA}/^\circ\text{C}$
T_{MIN} to T_{MAX}	$V_{CM} = 0\text{ V}$		80	250		50	150		80	250	pA
T_{MIN} to T_{MAX}	$V_{CM} = \pm 13.5\text{ V}$		80	450		50	350		80	450	pA
FREQUENCY RESPONSE											
Unity Gain			0.4	0.8		0.4	0.8		0.4	0.8	MHz
Crossover Frequency			0.1	0.15		0.1	0.15		0.1	0.15	V/ μs
Slew Rate, Unity Gain	$G = -1$		0.05	0.15		0.05	0.15		0.05	0.15	V/ μs
Slew Rate	T_{MIN} to T_{MAX}		0.05	0.15		0.05	0.15		0.05	0.15	V/ μs
INPUT IMPEDANCE											
Differential			40 2			40 2			40 2		$\text{M}\Omega \text{pF}$
Common Mode			300 2			300 2			300 2		$\text{G}\Omega \text{pF}$
INPUT VOLTAGE RANGE											
Common-Mode Voltage			± 13.5	± 14		± 13.5	± 14		± 13.5	± 14	V
COMMON-MODE REJECTION RATIO											
	$V_{CM} = \pm 13.5\text{ V}$	110	132		114	132		114	132		dB
	T_{MIN} to T_{MAX}	108	128		108	128		108	128		dB
INPUT VOLTAGE NOISE											
	0.1 Hz to 10 Hz		0.5			0.5	1.0		0.5	1.0	$\mu\text{V p-p}$
	$f = 10\text{ Hz}$		17			17			17		$\text{nV}/\sqrt{\text{Hz}}$
	$f = 1\text{ kHz}$		15	22		15	22		15	22	$\text{nV}/\sqrt{\text{Hz}}$
INPUT CURRENT NOISE											
	$f = 10\text{ Hz}$		50			50			50		$\text{fA}/\sqrt{\text{Hz}}$
OPEN-LOOP GAIN											
	$V_O = \pm 12\text{ V}$		300	2000		400	2000		400	2000	V/mV
	$R_{LOAD} = 10\text{ k}\Omega$		200	1500		300	1500		300	1500	V/mV
	T_{MIN} to T_{MAX}		200	1500		300	1500		300	1500	V/mV
	$V_O = \pm 10\text{ V}$		200	1000		300	1000		300	1000	V/mV
	$R_{LOAD} = 2\text{ k}\Omega$		150	1000		200	1000		200	1000	V/mV
	T_{MIN} to T_{MAX}		150	1000		200	1000		200	1000	V/mV
OUTPUT CHARACTERISTICS											
Voltage Swing	$R_{LOAD} = 10\text{ k}\Omega$	± 13	± 14		± 13	± 14		± 13	± 14		V
Current	T_{MIN} to T_{MAX}	± 13	± 14		± 13	± 14		± 13	± 14		V
Capacitive Load	Short Circuit		± 15			± 15			± 15		mA
Drive Capability	Gain = +1		10,000			10,000			10,000		pF
Output Resistance	Open Loop		200			200			200		Ω
POWER SUPPLY											
Rated Performance			± 15			± 15			± 15		V
Operating Range		± 2.0	± 18		± 2.0	± 18		± 2.0	± 18		V
Quiescent Current	T_{MIN} to T_{MAX}		380	600		380	600		380	600	μA
			400	800		400	800		400	800	μA
TEMPERATURE RANGE FOR RATED PERFORMANCE											
Commercial (0°C to $+70^\circ\text{C}$)			AD705J			AD705K			AD705T		
Industrial (-40°C to $+85^\circ\text{C}$)			AD705A			AD705B					
Military (-55°C to $+125^\circ\text{C}$)											

Parameter	Conditions	AD705J/A			AD705K/B			AD705T			Units
		Min	Typ	Max	Min	Typ	Max	Min	Typ	Max	
PACKAGE OPTIONS 8-Pin Cerdip (Q-8) 8-Pin Plastic Mini-DIP (N-8) 8-Pin SOIC (R-8) Chips			AD705AQ AD705JN AD705JR AD705JCHIPS			AD705BQ AD705KN			AD705TQ		
TRANSISTOR COUNT	# of Transistors		45			45			45		

NOTES

¹Bias current specifications are guaranteed maximum at either input.

All min and max specifications are guaranteed

Specifications in **boldface** are tested on all production units at final electrical test. Results from those tests are used to calculate outgoing quality levels.

Specifications subject to change without notice.

METALIZATION PHOTOGRAPH

Dimensions shown in inches and (mm).

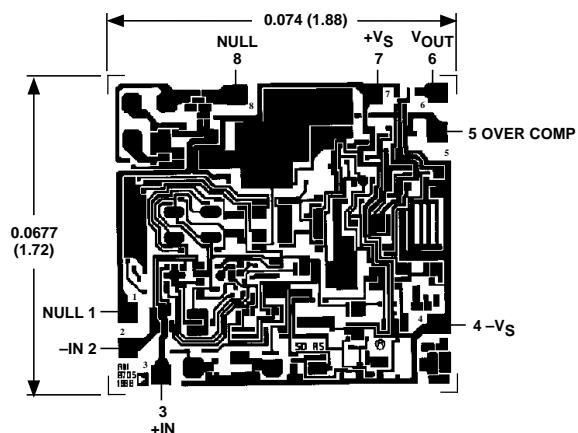

ABSOLUTE MAXIMUM RATINGS¹

Supply Voltage	±18 V
Internal Power Dissipation ²	650 mW
Input Voltage	±V _S
Differential Input Voltage ³	±0.7 V
Output Short Circuit Duration	Indefinite
Storage Temperature Range (N, R)	-65°C to +125°C
Storage Temperature Range (Q)	-65°C to +150°C
Operating Temperature Range	
AD705J/K	0°C to +70°C
AD705A/B	-40°C to +85°C
AD705T	-55°C to +125°C
Lead Temperature Range (Soldering 60 sec)	+300°C

NOTES

¹Stresses above those listed under “Absolute Maximum Ratings” may cause permanent damage to the device. This is a stress rating only and functional operation of the device at these or any other conditions above those indicated in the operational section of this specification is not implied. Exposure to absolute maximum rating conditions for extended periods may affect device reliability.

²Specification is for device in free air:

8-Pin Plastic Package: $\theta_{JA} = 165^\circ\text{C/Watt}$

8-Pin Cerdip Package: $\theta_{JA} = 110^\circ\text{C/Watt}$

8-Pin Small Outline Package: $\theta_{JA} = 155^\circ\text{C/Watt}$

³The input pins of these amplifiers are protected by back-to-back diodes. If the differential voltage exceeds ±0.7 V, external series protection resistors should be added to limit the input current to less than 25 mA.

ORDERING GUIDE

Model	Temperature Range	Package Description	Package Option
AD705AQ	-40°C to +85°C	8-Pin Ceramic DIP	Q-8
AD705BQ	-40°C to +85°C	8-Pin Ceramic DIP	Q-8
AD705JCHIPS	0°C to +70°C	Bare Die	
AD705JN	0°C to +70°C	8-Pin Plastic DIP	N-8
AD705JR	0°C to +70°C	8-Pin Plastic SOIC	R-8
AD705JR-REEL	0°C to +70°C	8-Pin Plastic SOIC	R-8
AD705JR-REEL7	0°C to +70°C	8-Pin Plastic SOIC	R-8
AD705KN	0°C to +70°C	8-Pin Plastic DIP	N-8
AD705TQ	-55°C to +125°C	8-Pin Ceramic DIP	Q-8
AD705TQ/883B	-55°C to +125°C	8-Pin Ceramic DIP	Q-8

CAUTION

ESD (electrostatic discharge) sensitive device. Electrostatic charges as high as 4000 V readily accumulate on the human body and test equipment and can discharge without detection. Although the AD705 features proprietary ESD protection circuitry, permanent damage may occur on devices subjected to high energy electrostatic discharges. Therefore, proper ESD precautions are recommended to avoid performance degradation or loss of functionality.



AD705—Typical Characteristics (@ +25°C, $V_S = \pm 15$ V, unless otherwise noted)

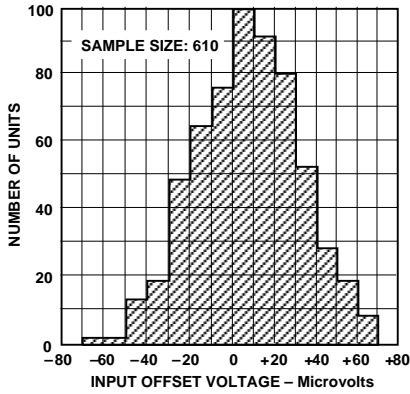

Figure 1. Typical Distribution of Input Offset Voltage

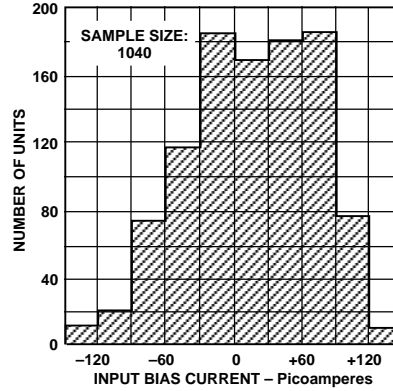

Figure 2. Typical Distribution of Input Bias Current

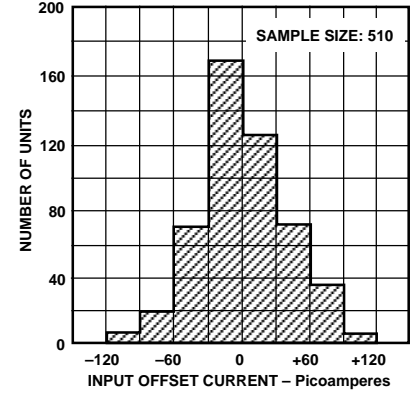

Figure 3. Typical Distribution of Input Offset Current

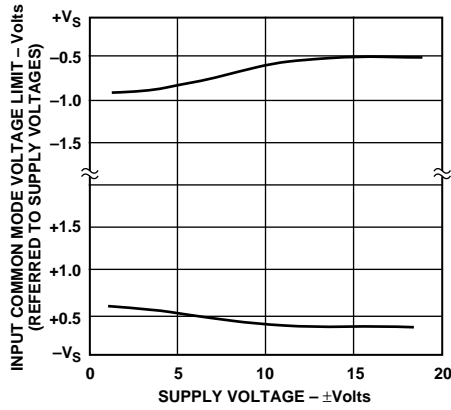

Figure 4. Input Common-Mode Voltage Range vs. Supply Voltage

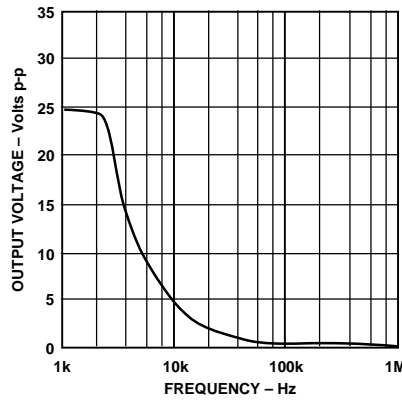

Figure 5. Large Signal Frequency Response

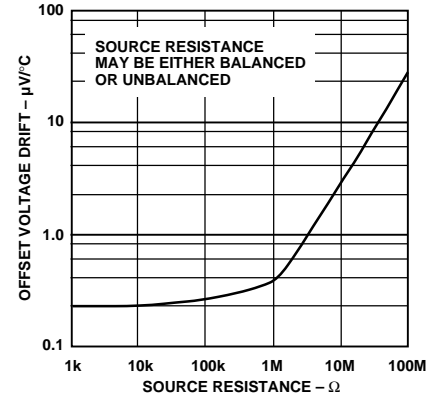

Figure 6. Offset Voltage Drift vs. Source Resistance

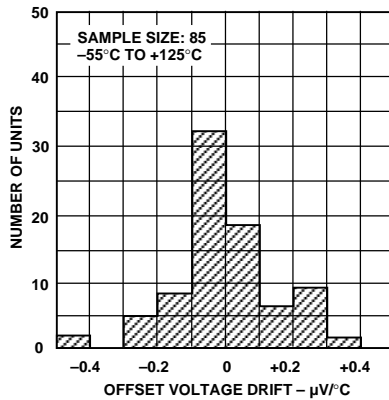

Figure 7. Typical Distribution of Offset Voltage Drift

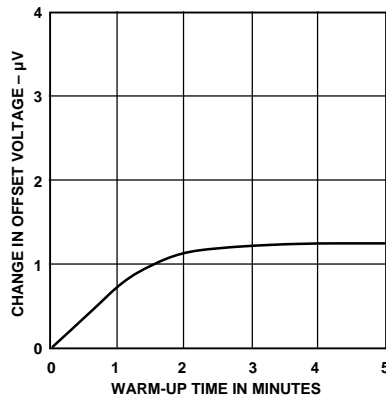

Figure 8. Change in Input Offset Voltage vs. Warm-Up Time

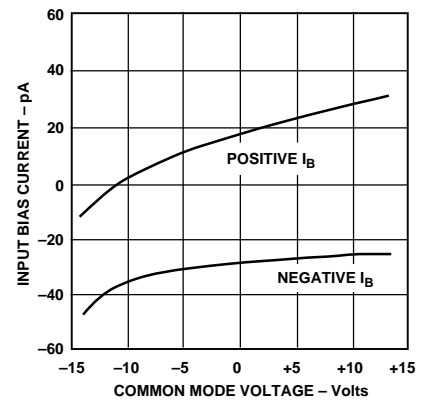

Figure 9. Input Bias Current vs. Common-Mode Voltage

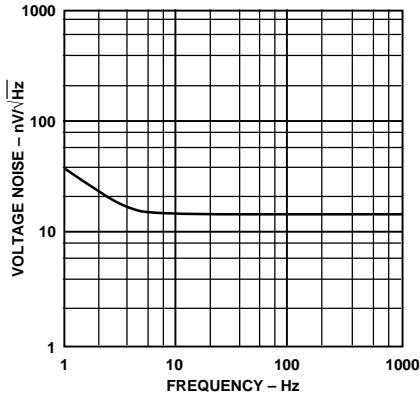

Figure 10. Input Noise Voltage Spectral Density

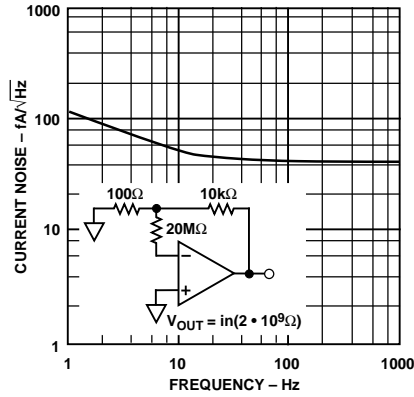

Figure 11. Input Noise Current Spectral Density

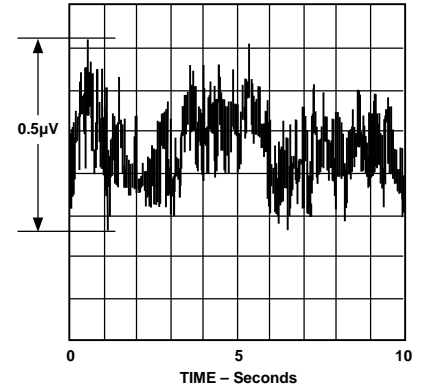

Figure 12. 0.1 Hz to 10 Hz Noise Voltage

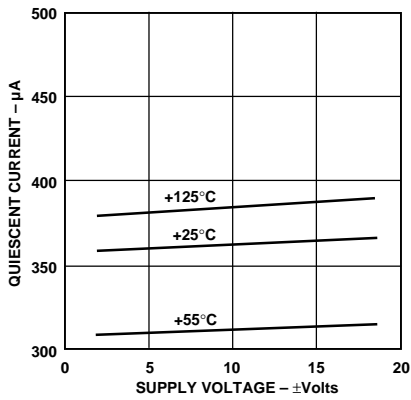

Figure 13. Quiescent Supply Current vs. Supply Voltage

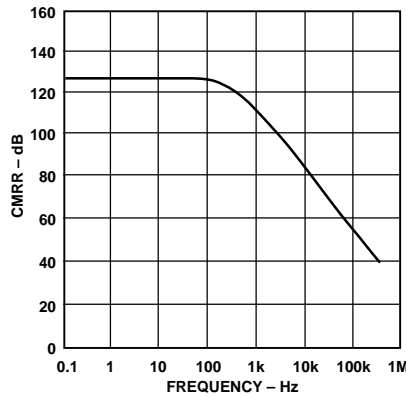

Figure 14. Common-Mode Rejection vs. Frequency

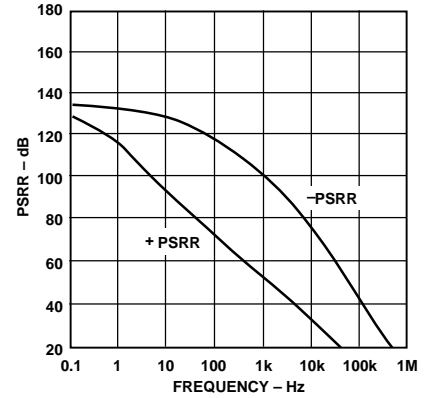

Figure 15. Power Supply Rejection vs. Frequency

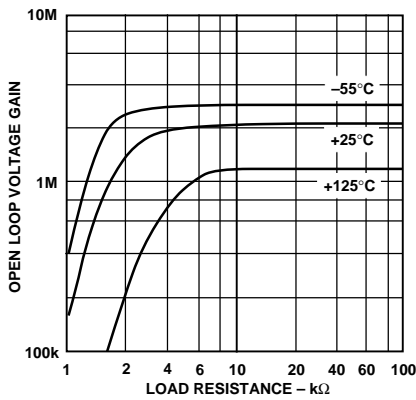

Figure 16. Open Loop Gain vs. Load Resistance over Temperature

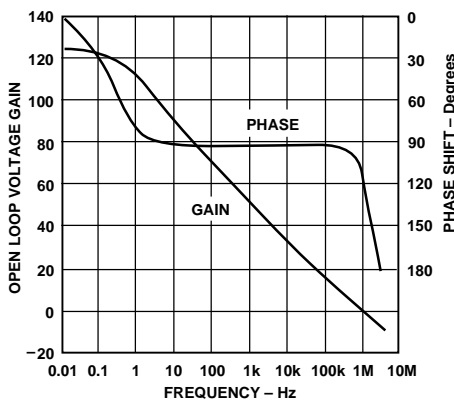

Figure 17. Open Loop Gain and Phase Shift vs. Frequency

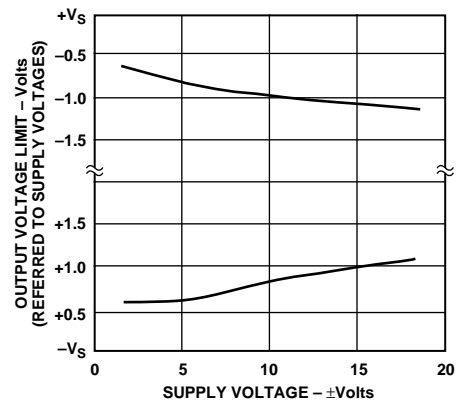

Figure 18. Output Voltage Limit vs. Supply Voltage

AD705

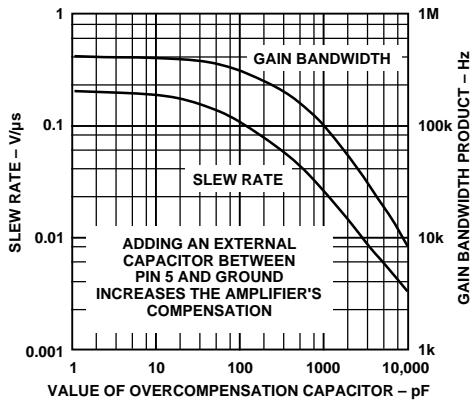

Figure 19. Slew Rate & Gain Bandwidth Product vs. Value of Overcompensation Capacitor

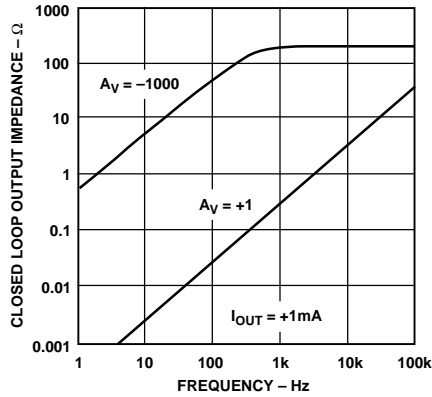

Figure 20. Magnitude of Closed Loop Output Impedance vs. Frequency

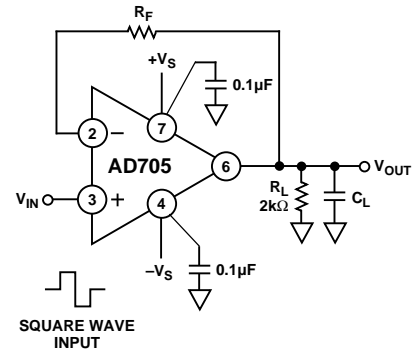

Figure 21a. Unity Gain Follower (For Large Signal Applications, Resistor R_F Limits the Current Through the Input Protection Diodes)

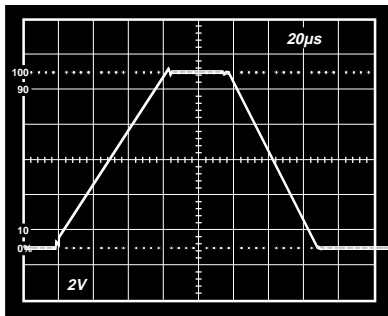

Figure 21b. Unity Gain Follower Large Signal Pulse Response $R_F = 10 \text{ k}\Omega$, $C_L = 50 \text{ pF}$

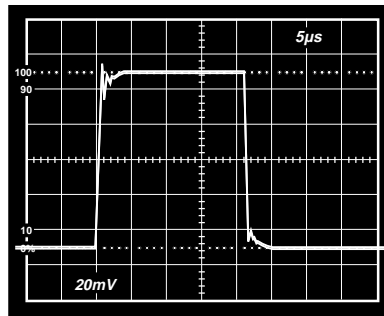

Figure 21c. Unity Gain Follower Small Signal Pulse Response $R_F = 0 \Omega$, $C_L = 100 \text{ pF}$

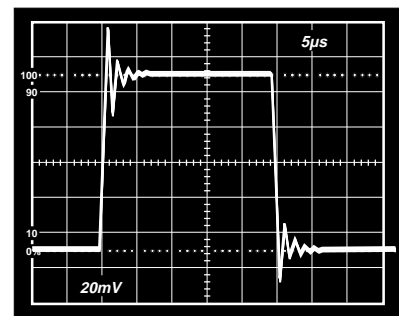

Figure 21d. Unity Gain Follower Small Signal Pulse Response $R_F = 0 \Omega$, $C_L = 1000 \text{ pF}$

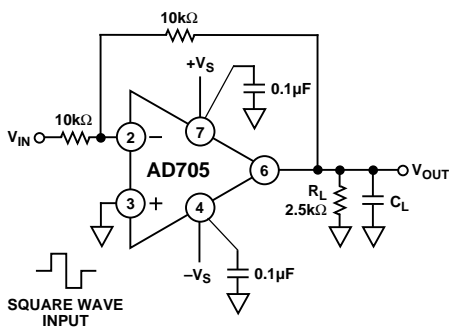

Figure 22a. Unity Gain Inverter

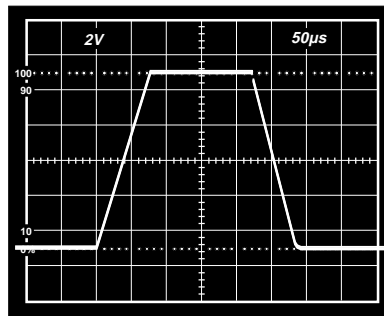

Figure 22b. Unity Gain Inverter Large Signal Pulse Response $C_L = 50 \text{ pF}$

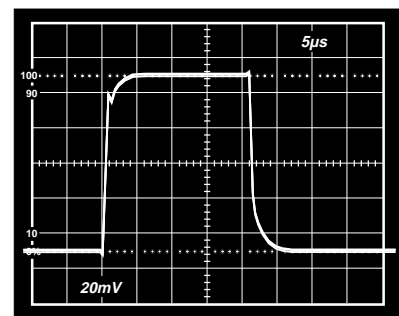

Figure 22c. Unity Gain Inverter Small Signal Pulse Response $C_L = 100 \text{ pF}$

AD705

A 1 Hz, 2-Pole, Active Filter

Table II gives recommended component values for the 1 Hz filter of Figure 26. An unusual characteristic of the AD705 is that both the input bias current and the input offset current and their drift remain low over most of the op amps rated temperature range. Therefore, for most applications, there is no need to use the normal balancing resistor tied between the noninverting terminal of the op amp and ground. Eliminating the standard balancing resistor reduces board space and lowers circuit noise. However, this resistor is needed at temperatures above 110°C, because input bias current starts to change rapidly, as shown by Figure 27.

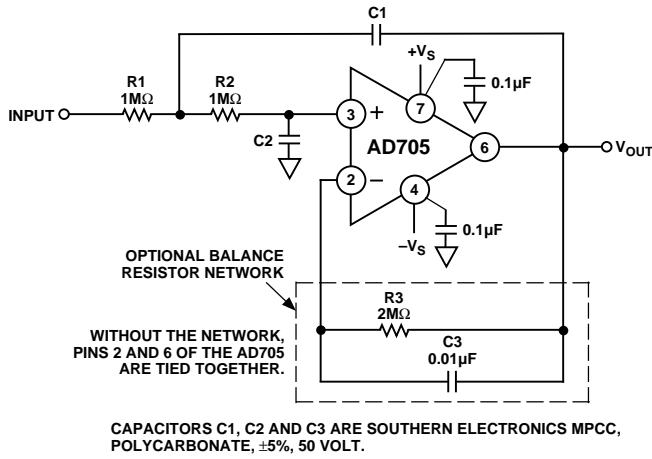

Figure 26. A 1 Hz, 2-Pole Active Filter

Table II. Recommended Component Values for the 1 Hz Low-Pass Filter

Desired Low Pass Response	Pole Frequency (Hz)	Pole Q	C1 Value (μF)	C2 Value (μF)
Bessel Response	1.27	0.58	0.14	0.11
Butterworth Response	1.00	0.707	0.23	0.11
0.1 dB Chebychev	0.93	0.77	0.26	0.11
0.2 dB Chebychev	0.90	0.80	0.28	0.11
0.5 dB Chebychev	0.85	0.86	0.32	0.11
1.0 dB Chebychev	0.80	0.96	0.38	0.10

Specified values are for a -3 dB point of 1.0 Hz. For other frequencies, simply scale capacitors C1 and C2 directly; i.e., for 3 Hz Bessel response, C1 = 0.046 μF, C2 = 0.037 μF.

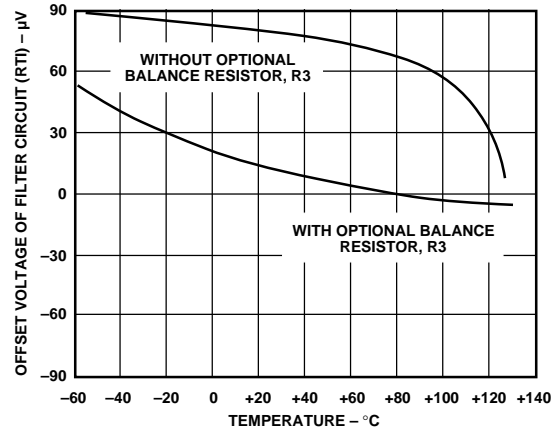
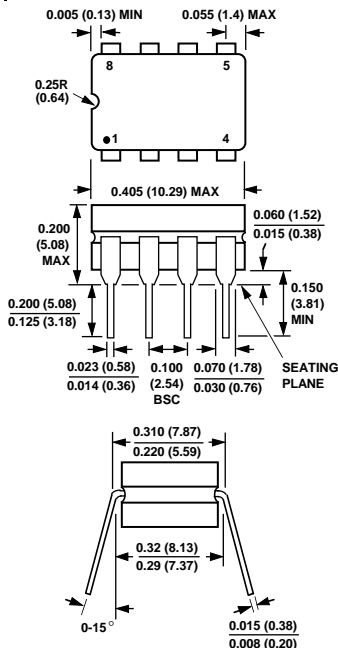

Figure 27. V_{OS} vs. Temperature of 1 Hz Filter

OUTLINE DIMENSIONS

Dimensions shown in inches and (mm).

Cerdip (Q) Package



Plastic Mini-DIP (N) Package

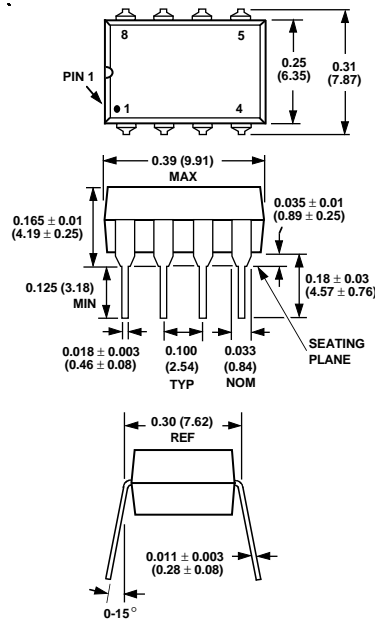

8-Pin SOIC (R) Package

